

# Super Panel User Guide

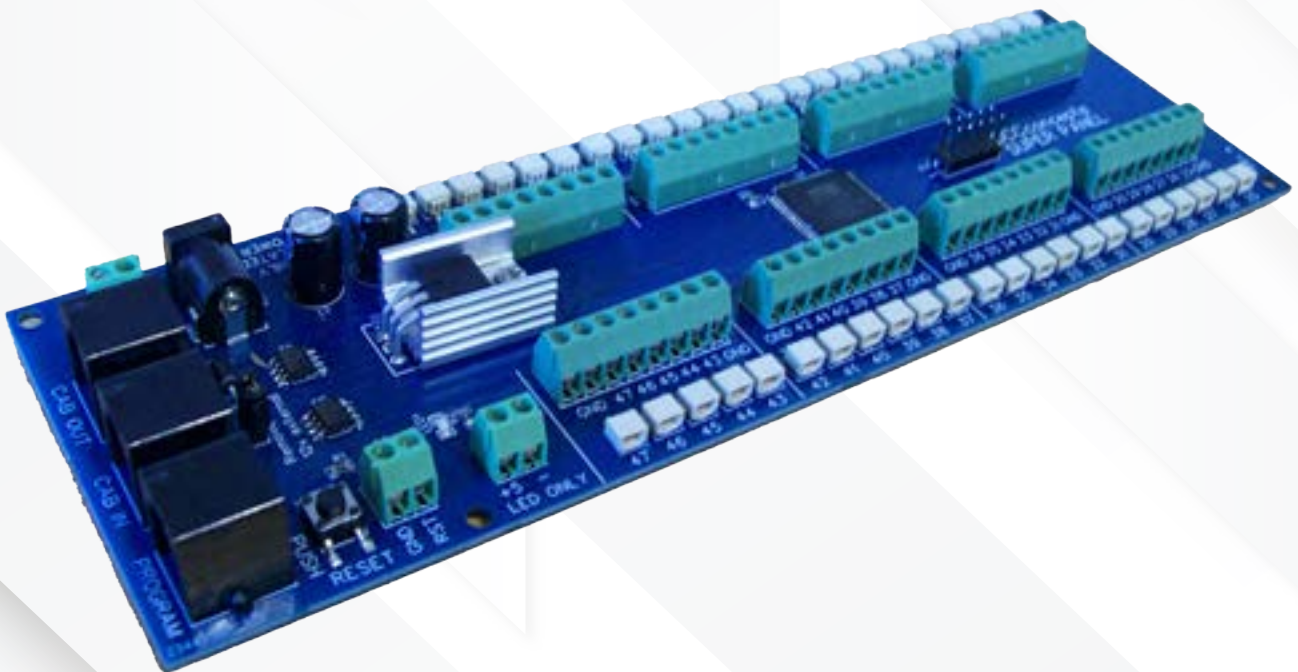

**Build your own, one of a kind, control panel, for control of accessories, locomotives and signals, without any complicated wiring.**

Version 1.13

**L A Y O U T**

**##### C O N C E P T S #####**

# Contents

## Contents

	2
<b>Summary</b>	<b>5</b>
<b>Features</b>	<b>5</b>
<b>1 - Internal Commands</b>	<b>6</b>
<b>2 - Terminology</b>	<b>6</b>
<b>3 - Basic Configuration</b>	<b>7</b>
<b>3.1 - Connecting An NCE Power Pro</b>	<b>8</b>
<b>3.2 - Connecting An NCE Power Cab - Option 01</b>	<b>8</b>
<b>3.3 - Connecting An NCE Power Cab - Option 02</b>	<b>9</b>
<b>Things To Be Aware Of At The Start</b>	<b>9</b>
<b>4 - Connecting Switches And Input Devices</b>	<b>10</b>
<b>4.1 - Connecting Output Devices</b>	<b>11</b>
Driving An LED - Option 1	11
Driving An LED - Option 2	11
Driving An LED - Option 3	12
Driving An LED - Option 4	12
Connecting A Relay - Option 1	13
Connecting A Relay - Option 2	13
<b>5 - Menu Navigation</b>	<b>14</b>
<b>6 - Super Panel Configuration</b>	<b>17</b>
<b>6.1 - Setting The Super Panel CAB Bus Address</b>	<b>18</b>
<b>Common CAB Address Bus Usages</b>	<b>19</b>
<b>6.2 - Factory Reset</b>	<b>20</b>
<b>6.3 - Reserve Any Inputs Which Are Not Going To Be Used</b>	<b>21</b>
<b>6.4 - Allocate An Input To Interrupt <i>WAIT</i> States Or <i>HOLD</i> Command Execution</b>	<b>23</b>
<b>6.5 - Set The Highest Address That The Super Panel Will Poll To Find A Programming CAB</b>	<b>25</b>
<b>6.6 - Select Inputs As Outputs</b>	<b>26</b>
<b>6.7 - Setting The Mode Of The On-Board LED</b>	<b>28</b>
<b>6.8 - Set An Input To Be Monitored By The On-Board LED</b>	<b>30</b>
<b>6.9 - Set The Start-Of-Day Initialisation Mode</b>	<b>31</b>

6.10 - Set The Start-Of-Day Initialisation Delay	33
6.11 - Set the Command Post Action Delay	35
<b>7 - Configuring Program Steps For Inputs</b>	<b>36</b>
<b>Super Panel Commands</b>	<b>38</b>
7.1 - ACCY - 1 = Accessory Number	39
7.2 - MACRO - 2 = Macro Number	41
7.3 - LOCO - 3 = Locomotive Menus	42
7.3.1 - LOCO# - 1 = Locomotive Number	42
7.3.2 - SPEED - 2 = Locomotive Speed	44
7.3.3 - FUNCTIONS - 3 = Locomotive Functions	45
7.3.4 - MOMENTUM - 4 = Locomotive Momentum	47
7.3.5 - LOCO OPS CV - 5 = Locomotive CV Settings	48
7.4 - SIGNAL - 4 = Signal Control	49
7.5 - OTHER - 5 = Changes Various Values	50
7.5.1 - DELAY - 1 = Delay Command	50
7.5.2 - WAIT - 2 = Wait Command	51
7.5.3 - LINK - 3 = Link Command	52
7.5.4 - OPS CV - 4 = Ops CV Command	53
7.5.5 - SKIP - 5 = Skip Command	54
7.5.6 - JUMP - 6 = Jump Command	55
7.5.7 - LOCO IN BLOCK - 7 = Loco In Block Command	56
7.5.8 - ACTIVATE ANOTHER INPUT - 8 = Active Another Input Command	57
7.5.9 - NOOP - 9 = No Operation Command	58
7.5.10 - END - 0 = End Command	59
7.6 - MORE - 6 = Additional Commands	60
7.6.1 - SET OUTPUT PIN - 1 = Set Output Pin Command	60
7.6.2 - CANCEL INPUT - 2 = Cancel Input Command	61
7.6.3 - SET REGISTER TO VALUE - 3 = Set Register Command	62
7.6.4 - ADD VALUE TO REGISTER - 4 = Add To Register Command	63
7.6.5 - SKIP IF REGISTER EQUALS VALUE - 5 = Skip If Register Command	64
7.6.6 - WAIT IF REGISTER EQUALS VALUE - 6 = Wait If Register Command	65
7.6.7 - COPY REGISTER FROM REGISTER - 7 = Copy Register Command	66
<b>8 - EDIT - 9 = Edit Commands</b>	<b>67</b>
8.1 - INSERT - 1 = Insert Command	67
8.2 - DELETE - 2 = Delete Command	68
8.3 - COPY - 3 = Copy Command	69
8.4 - ERASE - 4 = Erase Command	70

8.5 - SWAP - 5 = Swap Command	71
9 - REVIEW - 2 = Review Commands	72
9.1 - REVIEW - 2 = Reviewing Commands Which Set Function Bits	74
10 - TESTING - 3 = Testing Commands	75
11 - DISPLAY INPUT STATUS - 5 = Display Input Status Command	76
11.1 - INPUT 99 STATUS - Display All Inputs That Are Busy Command	78
12 - TESTING & SETTING OUTPUTS - 6 = Testing & Setting Output Commands	79
13 - START OF DAY INITIALISATION - 4 = Start Of Day Initialisation Command	80
14 - SETTING THE MODE OF AN INPUT - 7 = Setting the Mode Command	82
15 - SETTING INTERNAL REGISTER VALUES - 8 = Setting & Reviewing Commands	84
ELECTRICAL SPECIFICATION	85
Appendix 1 - Command Considerations Within The Super Panel	87
Appendix 2 - Menu Layout	88
Appendix 3 - HEX	89
Appendix 4 - Programming Sheets	90

# Super Panel

## Summary

The Layout Concepts Super Panel is similar in concept to the NCE Mini Panel, with more powerful features & usability. It is designed to be used as a fully digital DCC model railway control panel, with the panel or panels being mobile and plugged in various locations around the layout.

Super Panel can be used for complex route setting, point/turnout indication, and many automation tasks on the layout. For example, a small display layout at an exhibition can be programmed to run a set of actions, meaning the layout can operate whilst the operator is away.

## Features

- The Layout Concepts Super Panel has 47 physical switch inputs, plus a further 3 phantom inputs not associated to any physical connection.
- Any of the 47 inputs can be connected to PUSH-BUTTONS, TOGGLE SWITCHES and/or RELAYS. This also includes devices such as the Layout Concepts LM-iD Block Detector, and any other device that provides a 5V logic output.
- The device is specifically designed to operate with toggle switches and relays that remain CLOSED.
- All of the 47 inputs can be programmed with up to 20 COMMAND STEPS, either as SWITCH CLOSED or SWITCH OPEN state. This allows the user to now control a turnout using ONE toggle switch connected to ONE input. This means the Super Panel can control 47 turnouts, including crossover where pairs of turnouts are controlled as one unit.
- The 20 command step allows complex ladder routing, using push buttons, and point indication to which route has been chosen.
- You can assign some of the inputs to be outputs, hence LEDs can be driven directly from the panel.
- Super Panel also includes a user controlled 'start of day' setup where all points/turnouts or accessories align with the control panel switches when power is applied to the layout.

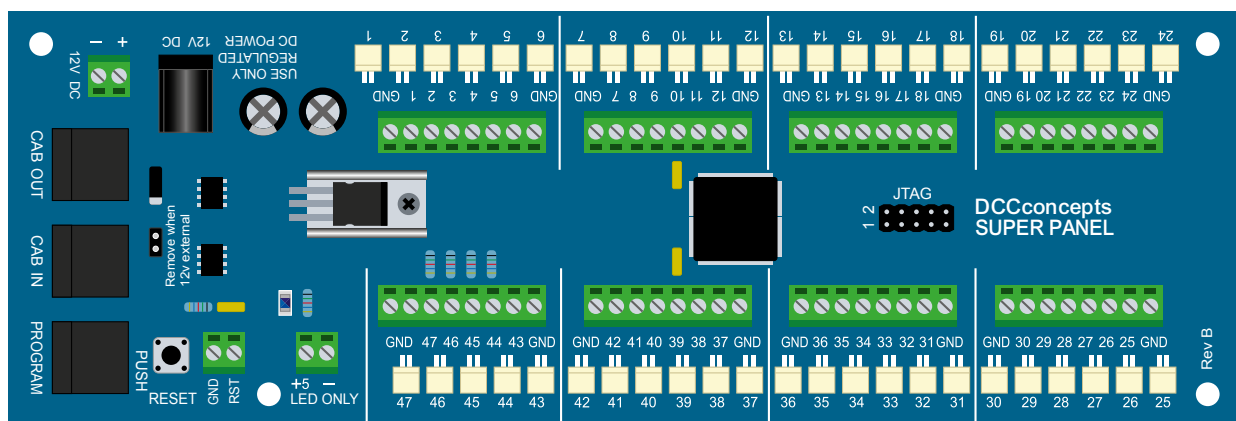

## 1 - Internal Commands

The Super Panel provides internal commands which do send any commands back to the command station, meaning they are executed locally only. These include:

- Delay of 1 to 255 in  $\frac{1}{4}$  seconds i.e. range =  $\frac{1}{4}$  second to 63 seconds, or 4-seconds, range = 4 seconds to 1020 seconds.
- Wait until another input is activated, switch-closed, or deactivated, switch-open, or that input's command sequence is complete.
- Skip the next 1, 2, 4 or 8 commands if another input is active, switch-closed, or inactive switch-open, or its command sequence is complete.
- Jump to step 1-20, unconditionally.
- Link from the command set of one input to the low or high command set of another input so as to extend the number of commands available per input. With the Super Panel's 20 commands per set, you would normally only need this if you set up an extensive automation process.
- Activate another input's low or high command set, so as to start another activity in parallel with that of the initiating input.
- Cancel/stop the current actions of an input.
- Drive a connection, configured as an output, low or high, to light an LED on the control panel.
- Edit a sequence of command steps to insert a step, delete a step, copy an entire input or erase an entire input.
- View the state and status of an input, with the option to cancel activity.
- Monitor the state of an input in real-time via the on-board LED. This makes it easy to view the state of an input connected to, for example, a block detector during the set-up phase of a layout.
- Commands to set and test one of 16 internal user-level registers so as to achieve synchronisation between independent command streams and/or to alter the operation of command streams.

See later in the manual for details of how these internal commands can be used and how they are structured.

## 2 - Terminology

To avoid confusion the following are terms used in this manual:

The term **Switch-Closed** means that an input is connected to the **0 volts** or **ground** terminals on the Super Panel. In this state, an input has the logical value of 0, and is also said to be **LOW**, meaning it's at a low voltage, plus the input is said to be active. **So 'switch-closed' = logic 0 = LOW = active.**

The term **Switch-Open** means that an input is **NOT** connected and it therefore floats to a **HIGH** voltage, meaning +5 volts, via the internal pull-up resistors in the micro-controller. In this state the input has a logical value of **1**, plus the input is said to be inactive. **So 'switch-open' = logic 1 = HIGH = inactive.**

In all the menus displayed on the ProCab used to program the Super Panel, only the words **LOW** and **HIGH** are used because of the limited space on the display, and in some cases, these are abbreviated to **LO** and **HI** or even **L** and **H**. The **LOW** command set refers to the string of commands actioned when a switch is closed, active, and the **HIGH** command set refers to the commands actioned when the switch is open, inactive. For push-buttons, you would normally only use the **LOW** command set, but you would use both **LOW** and **HIGH** command sets with a toggle switch, and possibly also with a block detector.

### 3 - Basic Configuration

The diagram shows how the Super Panel can be connected up:

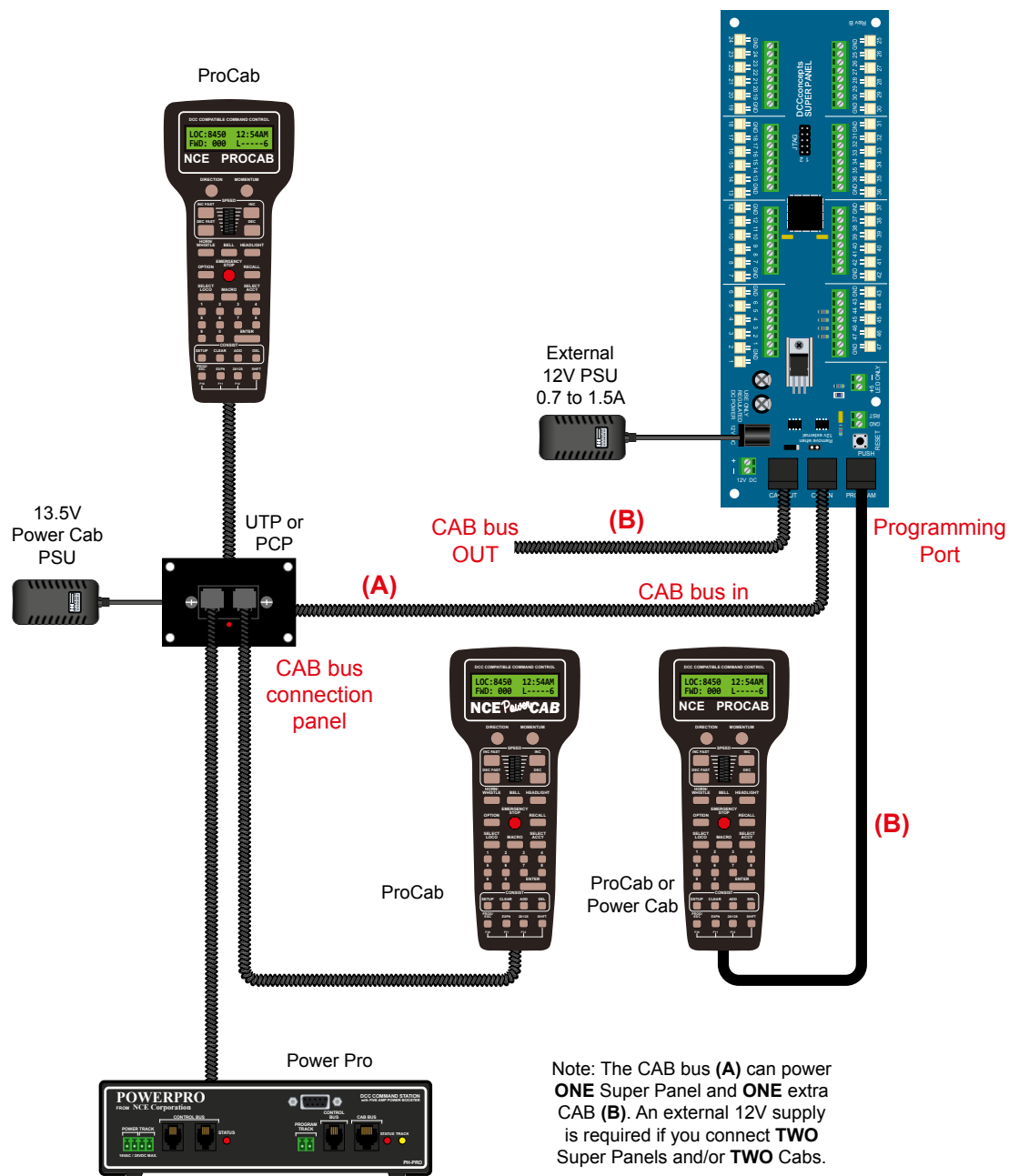

A PowerCab can power **ONE** Super Panel plus its programming Cab via the Cab Bus Cable.

If two or more Super Panels are daisy-chained or two or more PowerCabs are connected, for programming the Super Panel or panels, or as a down-stream control Cab, an external regulated 12 volt power supply of 0.7A to 1.5A is required. This plugs into the 2.5mm barrel connector on the first Super Panel.

When you use an external power supply, you must remove the jumper J1 to isolate the external supply from that coming via the Cab Bus cable.

You may also supply 12 volts via the screw terminal block alongside the barrel connector.

**Be aware that the power input is polarity sensitive but the Panel is protected internally if you connect wrongly. It simply won't work if you connect the power the wrong way round.**

### 3.1 - Connecting An NCE Power Pro

The diagram shows connection of NCE Power Pro to the Super Panel using Layout Concepts Alpha Power to power the Power Pro. Please note, cables used MUST BE the 6-core RJ12, such as our DCD-ACL.

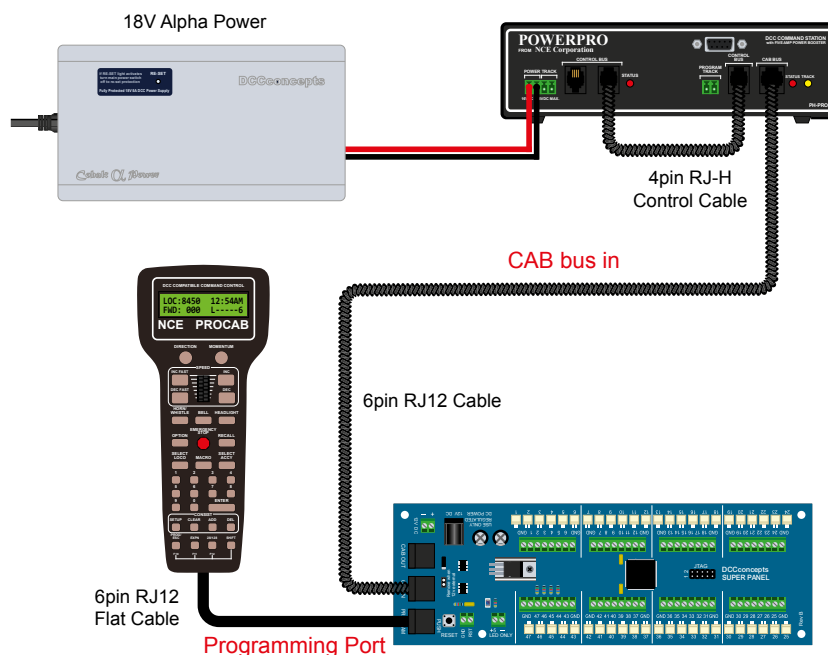

### 3.2 - Connecting An NCE Power Cab - Option 01

The diagram shows how to connect an NCE Power Cab to the Super Panel, using the NCE PCP faceplate. Please note, cables used MUST BE the 6-core RJ12, such as our DCD-ACL.

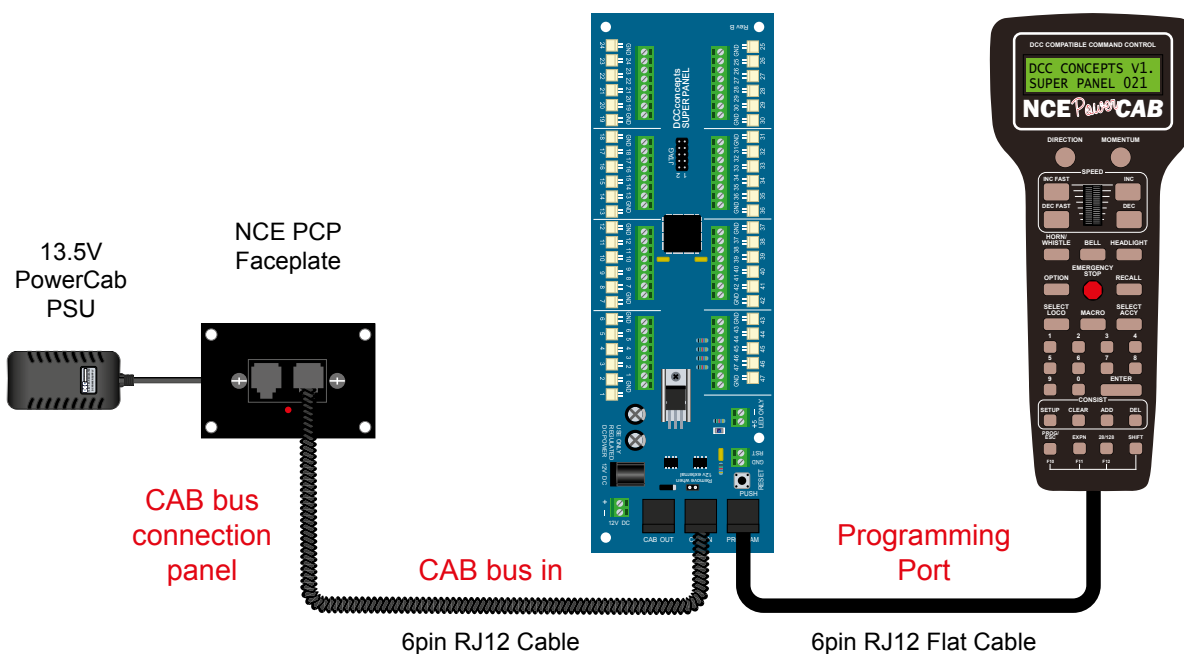

### 3.3 - Connecting An NCE Power Cab - Option 02

The diagram shows how to connect an NCE Power Cab to the Super Panel using the Layout Concepts Alpha Panel faceplate. Please note, all the cable used **MUST BE** the 6-core type, like the DCD-ACL.

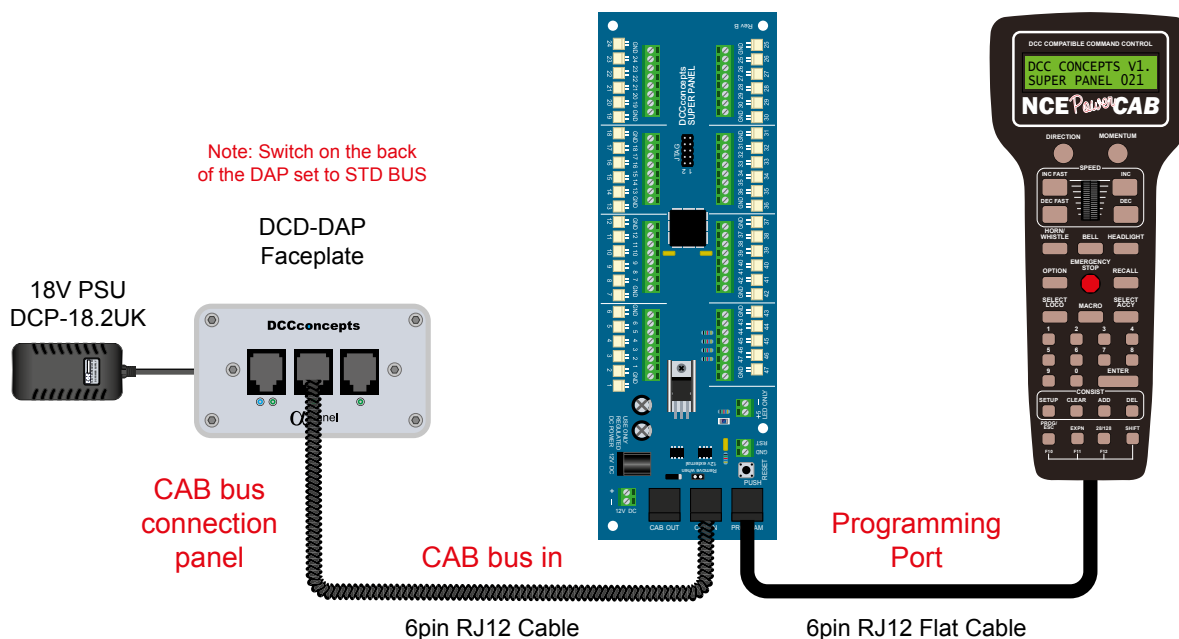

### Things To Be Aware Of At The Start

**Layout Concepts use this type of 2 pin JST sockets extensively on its products. These are usually used to connecting Mimic LEDs to a device/circuit board.**

**Please note, apart from connections 44, 45, 46 and 47, DO NOT DIRECTLY CONNECT ANY LEDs, Mimic or 3rd party, to the Super Panel on ANY OTHER connections, either using the screw terminals or the white sockets. If you do, you may damage Super Panel. The damage will not be covered by warranty.**

Please see pages 11 and 12 on how to connect external LEDs to your Super Panel.

The green screw terminals and white sockets are wired in parallel so they can **ONLY** be used as a dedicated **INPUT** or **OUTPUT** but **NOT** both at the same time.

Each Super Panel also has a 5 volt output-only terminal which may be used to power some LEDs, with series resistors. **DO NOT** feed 5 volts **INTO** this terminal because doing so could damage the on-board voltage regulator and/or the micro-controller. Such damage is also not warrantable.

If setting up more than one Super Panel, the programming ProCab must be connected to each of the Super Panels in turn. There is no 'feed through' of the programming functions from one Super Panel to another.

You can use PowerCab instead of a ProCab as the programming device. Please note that If you have **ONLY** got a PowerCab, you cannot use the 'test input' function because PowerCab is not able to action the commands when plugged into the programming port.

## 4 - Connecting Switches And Input Devices

The diagram shows how switches and other devices can be connected to the Super Panel:

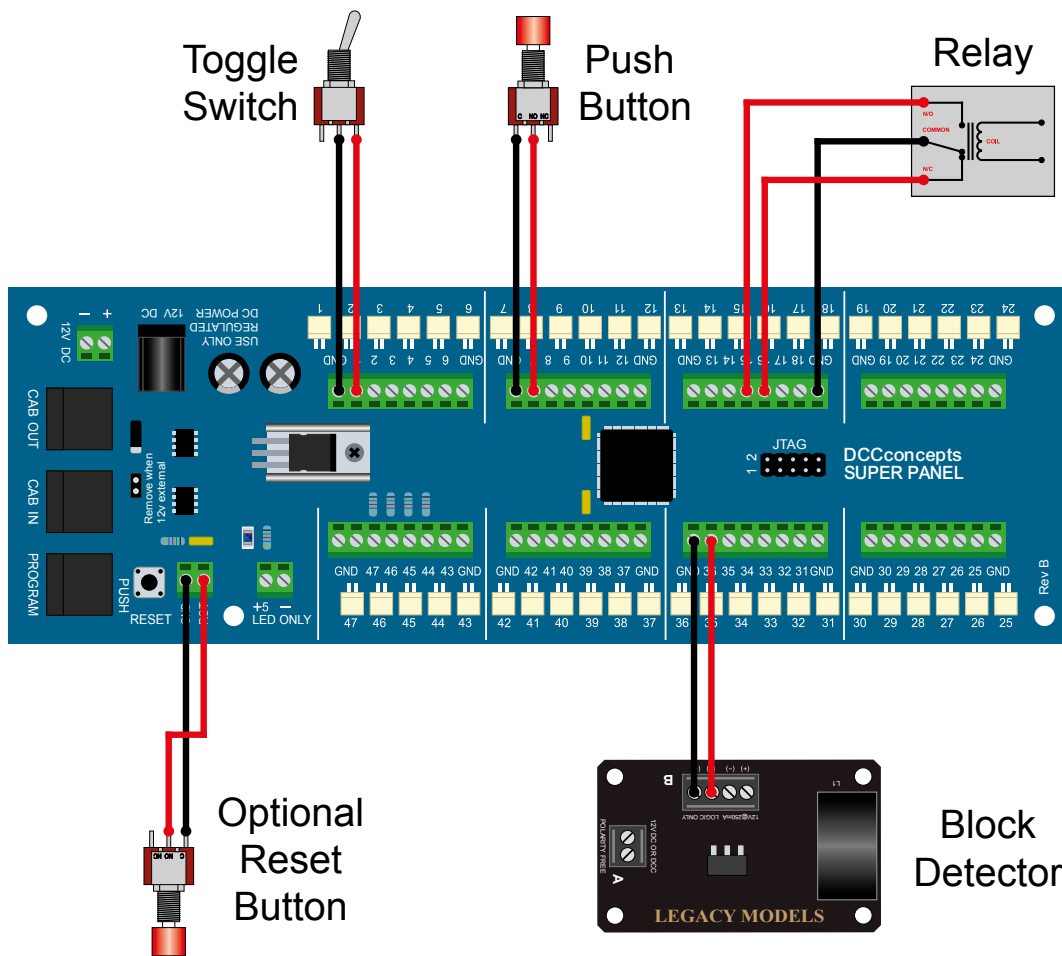

The on-board LED may be supplemented by an external LED without the need to use an additional series resistor. Connect it via the 2-position terminal block alongside the on-board LED. The anode is connected to 5 volts and the cathode to the 220 ohm series resistor on board.

If you have more than one Super Panel in the same control panel and you relocate the LEDs, use two separate wires for each LED.

**When adding 5V power to multiple Super panels, do NOT try to make common connections between the 5V power supplies to as their supplied voltages may be slightly different.**

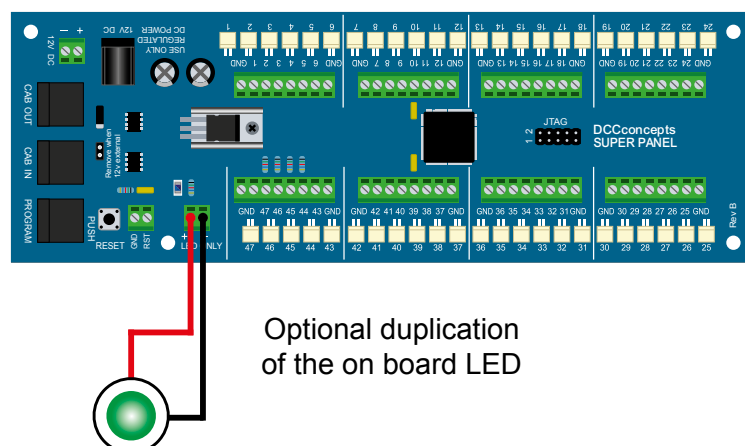

## 4.1 - Connecting Output Devices

The diagrams show 3 different ways to connect LEDs to the Super Panel when the inputs have been configured as outputs:

### Driving An LED - Option 1

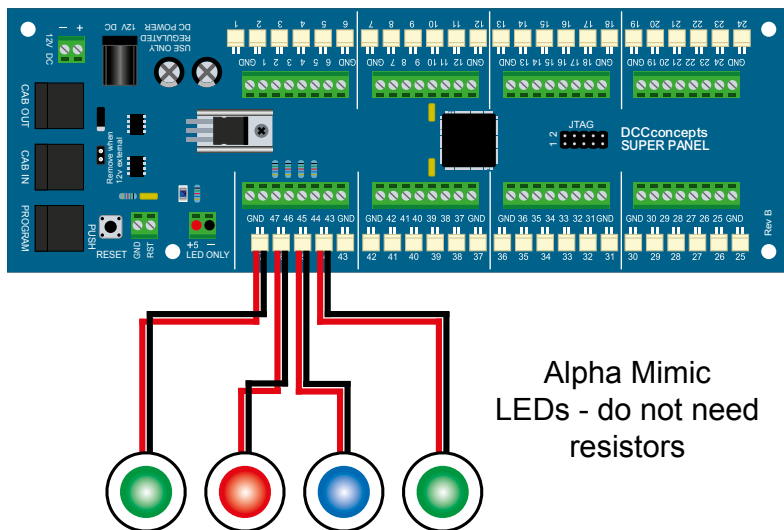

Do not connect LEDs to any of the outputs, other than 44, 45, 46, 47, without using an external driver device

Option 1 is the simplest and easiest way to connect an LED, shown on the left.

Outputs 44 to 47 are designed to be used with mimic LEDs, using the white JST sockets.

**DO NOT CONNECT ANY MIMIC OR OTHER TYPES OF LEDs TO ANY OTHER WHITE OUTPUTS SOCKETS OR YOU MAY DAMAGE THE SUPER PANEL AND THE LED.**

### Driving An LED - Option 2

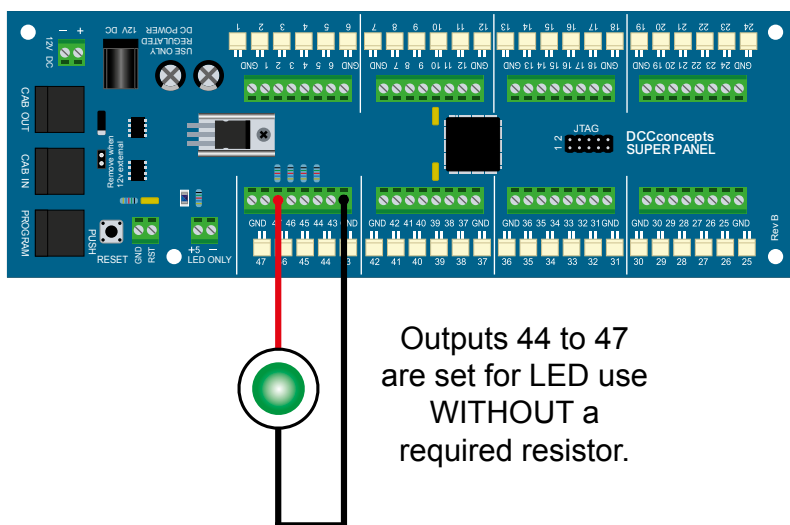

Option 2, is similar to Option 1 but uses any LED connected using the green screw terminals. Again no resistor is required.

The green screw terminals and the white JST sockets are wired in parallel. This means you can use EITHER one to connect an LED **BUT** not both.

**DO NOT CONNECT ANY MIMIC OR OTHER TYPES OF LEDs TO ANY OTHER WHITE OUTPUTS SOCKETS OR YOU MAY DAMAGE THE SUPER PANEL AND THE LED.**

## Driving An LED - Option 3

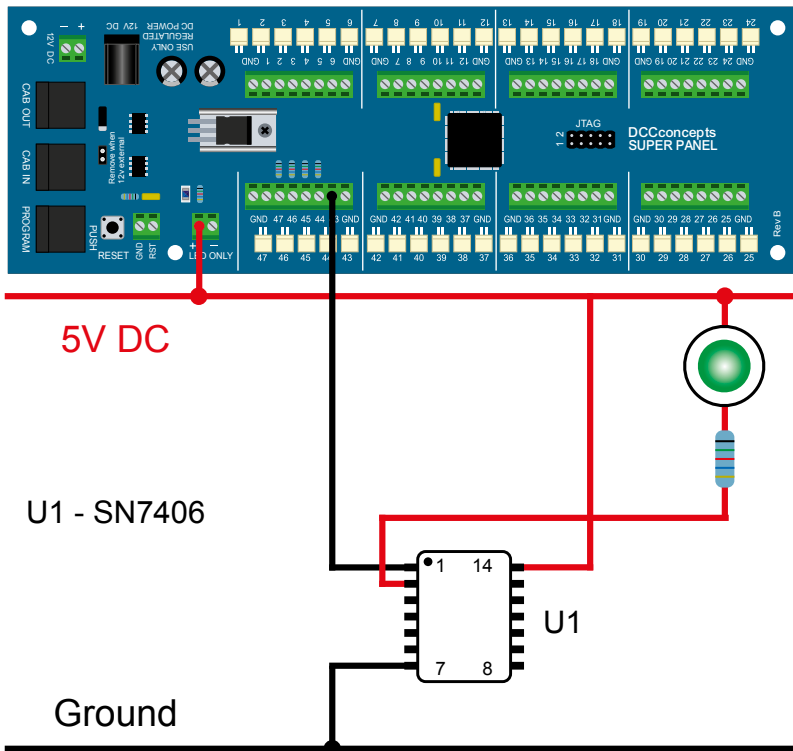

### EXPERTS ONLY

This option places the lowest drain on the micro-controller because the LED current passes through the buffer.

A low cost SN7406 inverter/or line driver/buffer can sink up to 50mA per output and there are six outputs in the 14-pin SN7406 package.

An SN7406 can therefore drive several LEDs.

In this example, the LED would be lit when the Super Panel output is High.

## Driving An LED - Option 4

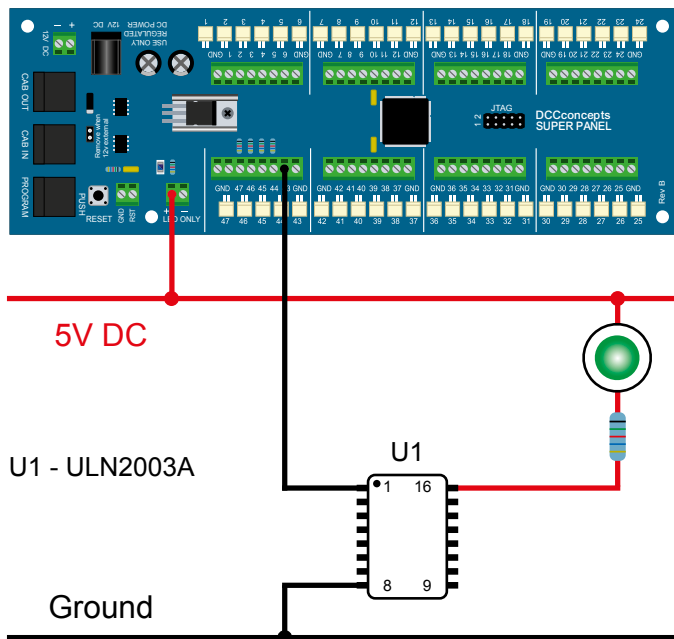

### EXPERTS ONLY

Option 4 uses the readily available ULN2003A integrated circuit. It is a Darlington array.

ULN2003A could potentially drive 7 LEDs from the Super Panel.

Series resistors are still required.

## Connecting A Relay - Option 1

The outputs from the Super Panel can be used to control a relay - option 1.

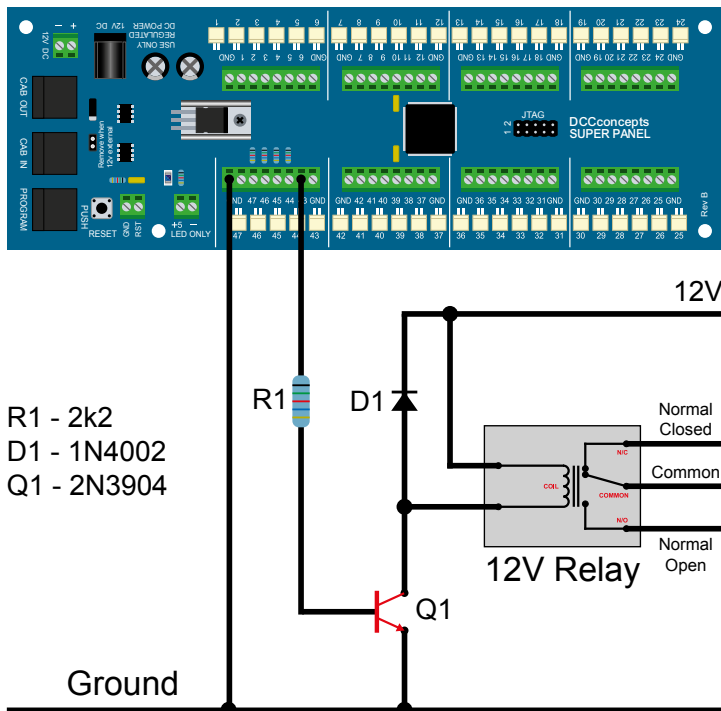

Here we have shown the possibility of the Super Panel output driving a relay.

This requires a suitable transistor and you **MUST** add a diode, **D1**, across the relay coil to protect against back-EMF.

The positive supply rail would depend on the relay and could be 5, 9 or 12V DC.

## Connecting A Relay - Option 2

The outputs from the Super Panel can be used to control a relay - option 2.

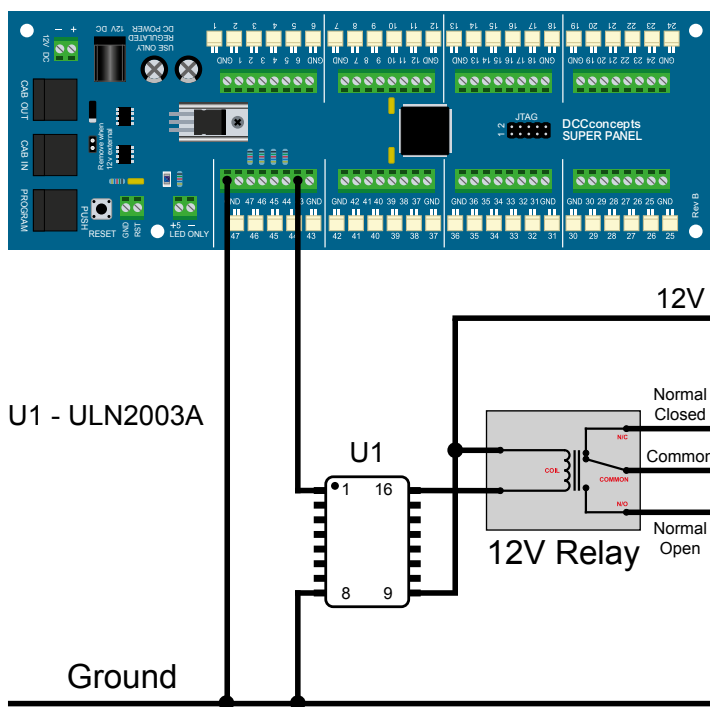

Here we have shown the second possibility of the Super Panel output driving a relay.

This uses a Darlington Array integrated circuit. This could potentially drive 7 relays from the Super Panel.

The positive supply rail would depend on the integrated circuit and the relay but normally 12V DC.

## 5 - Menu Navigation

The following common keys are used on the NCE Power Pro to enter data and navigate all menus. Some menus use extra keys and these will be identified in the appropriate section description.

After successfully connecting the Super Panel to the NCE Power Pro you should see the following screen on your NCE ProCab handset:

DCC CONCEPTS V1.  
SUPER PANEL 025B

To get to the **MAIN MENU** from the start screen, press the **ENTER** key on the NCE ProCab:

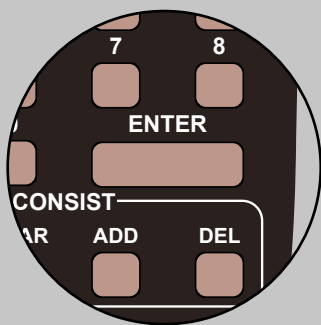

Press

ENTER

1=SETUP 2=REVIEW  
3=TEST OPERATION

At each menu level, there may be functions available that are not visible on the two-line screen. Press the **DEC** key to scroll down one line, moves the text up one line, or press the **INC** key to scroll up one line, moves the text down one line. You can also use **SPEED** control wheel to move the text up or down a line:

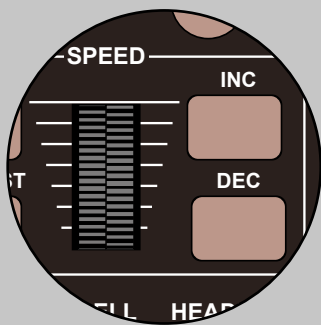

Press

INC

OR

DEL

OR Scroll

SPEED

4=INPUT INIT MNU  
5=INPUT STATUS

These are the Main Menu screens, with options from 1 to 8:

1=SETUP 2=REVIEW  
3=TEST OPERATION

4=INPUT INIT MNU  
5=INPUT STATUS

6=TEST OUTPUTS  
7=INPUT MODE MNU

7=INPUT MODE MNU  
8=USER REGISTERS

To select the required menu you require, and move to that screen push the corresponding **NUMBER** key on the ProCab main keypad:

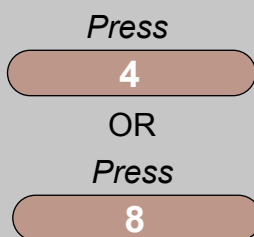
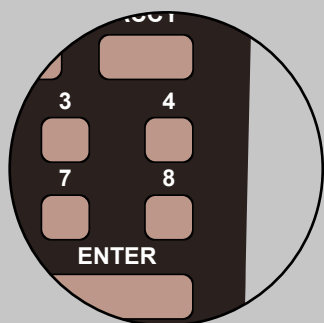

INITIALISATION:-  
INPUT: 1

USER REGISTERS  
REGISTER NUM: 0

To go back to the previous menu level, wherever you are, press the **PROG/ESC** key.

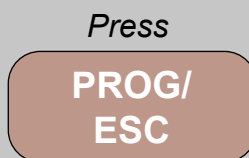
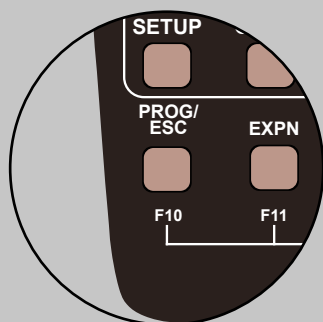

To enter numbers, press the **0** to **9** number keys. To erase or backspace during a number entry, press the **RECALL** key.

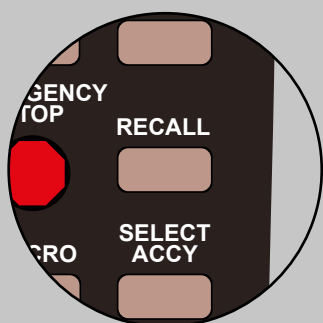

To accept a value that has been input, and generally move on to the next step, press the **ENTER** key.

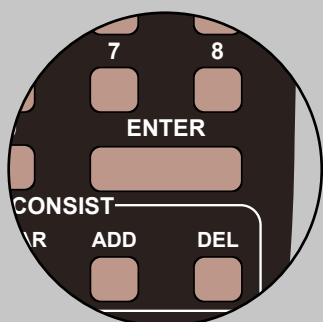

To select the locomotive 28 speed or 128 speed mode, press the **28/128** key. This will toggle the mode between 28 and 128.

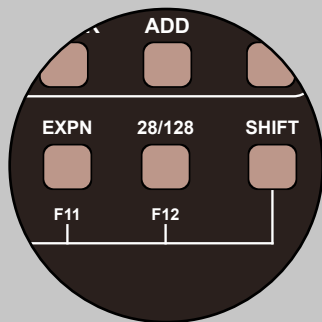

Press  
**28/128**

To select the locomotive direction, press the **DIRECTION** key. This will toggle between **FORWARD** and **REVERSE**.

To select the direction of an accessory, turnout, etc., press the **DIRECTION** key. This will toggle between **NORMAL** and **REVERSE**. You can also press **1** for **NORMAL** or **2** for **REVERSE**.

To select between the **Active/LOW** command set and the **Inactive/HIGH** command set of an input, press the **DIRECTION** key. This will toggle between **LOW** and **HIGH**.



Press  
**DIRECTION**

## Input/Review Short-Cut

When editing an existing input command list, pressing **MACRO** will toggle between the **SETUP INPUT** menu and the **REVIEW INPUT** menu for the input and step number currently selected.

Thus you can start off by reviewing commands for an input, low or high command set, and when you have displayed the step you want to change, press **MACRO** and the 'input' menu will be activated for that step.

If you don't want to change it, press **PROG/ESC** or press **MACRO** to take you back to the review process for the same step. If you do change it, the step number will be incremented automatically, so if you then press **MACRO**, you will be switched to review the step after the one you have just updated.

Press **DEC** if you want to review the step you have just changed. The **MACRO** key merely acts as a short cut to save you having to go back up to the top level menu from either the **SETUP INPUT** or **REVIEW INPUT** menus.

## 6 - Super Panel Configuration

Here is how you set up the basic functionality of the Super Panel

Connect the unit, the **START SCREEN** will appear, press **ENTER** to move to the **Main Menu**:

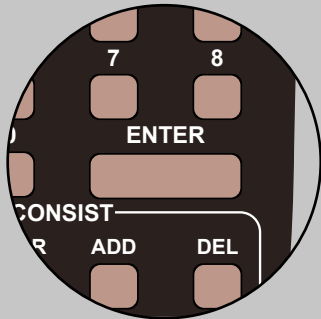

Start Screen

DCC CONCEPTS V1.  
SUPER PANEL 025B

Press

ENTER

1=SETUP 2=REVIEW  
3=TEST OPERATION

Select **1=SETUP** by pressing **1**, and then **2=SET CONFIG** by pressing **2**:

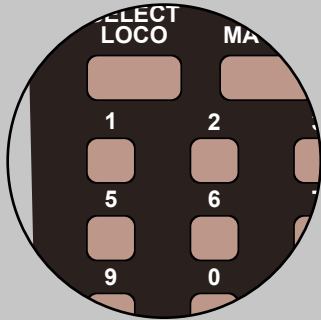

Press

1

THEN

Press

2

1=SETUP INPUT  
2=SETUP CONFIG

1=CAB ADDRESS >  
2=UNUSED INPUTS>

We will now look into the individual commands for configuring the Super Panel

These are the Super Panel Configuration screens, with options from 1 to 0:

1=CAB ADDRESS >  
2=UNUSED INPUTS>

3=HOLD/WAIT INT>  
4=HI PROG CAB AD

5=OUTPUT SELECT>  
6=LED MODE SEL >

7=INPUT MONITOR>  
8=INIT MODE SEL

9=SET INIT DELAY  
0=SET CMD DELAY

## 6.1 - Setting The Super Panel CAB Bus Address

Each Super Panel in your system **MUST** have a different CAB bus address. The Super Panel is delivered with a **CAB BUS ADDRESS** of 10. If you have more than one Super Panel on the bus, subsequent units will have to be assigned a different address. Valid addresses are 3 to 63 and the address chosen must not conflict with any other CABs, AIUs or Mini-Panels on the bus.

Connect the unit, the **START SCREEN** will appear, press **ENTER** to move to the **Main Menu**:

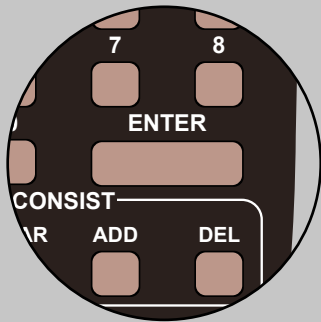

Start Screen

DCC CONCEPTS V1.  
SUPER PANEL 025B

Press

ENTER

1=SETUP 2=REVIEW  
3=TEST OPERATION

Select **1=SETUP** by pressing **1**, and then **2=SET CONFIG** by pressing **2**:

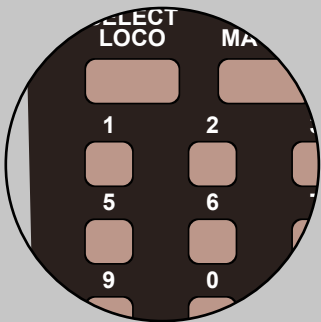

Press

1

THEN

Press

2

1=SETUP INPUT  
2=SETUP CONFIG

1=CAB ADDRESS >  
2=UNUSED INPUTS>

Select **1=CAB ADDRESS** by pressing **1**:

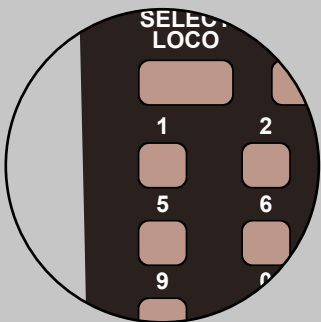

Press

1

CAB ADDRESS: 10

Select the CAB Bus Address you require, we are using **9**, so press **0** and then **9**. For **PowerCab's** use **8, 9** or **10**, and for **ProCab's** use **3** to **63**:

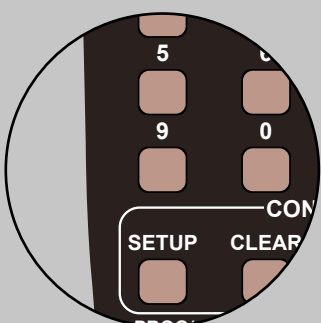

Press

0

Then Press

9

CAB ADDRESS: 09

Confirm your choice by pressing **ENTER**, then press **PROG/ESC** twice to return to the **MAIN MENU**:

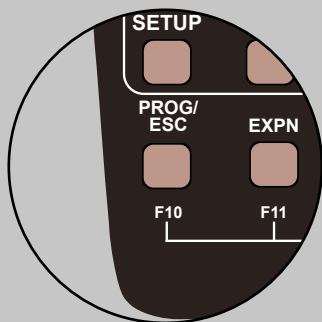

Press  
**ENTER**  
THEN  
Press *TWICE*  
**PROG/ESC**

1=CAB ADDRESS >  
2=UNUSED INPUTS>

1=SETUP 2=REVIEW  
3=TEST OPERATION

**Your CAB Bus Address is now set to 9.**

## Common CAB Address Bus Usages

**Common address usage would be:**

- A) Primary MASTER CAB on address 2; additional CABs on addresses 3, 4, 5 etc.
- B) Primary Super Panel is address 10.  
Additional Super Panels can be addresses 11,12,13, etc.

Power Pro systems can use any CAB address from 1 and 63.  
Power Cab systems can **ONLY** use 8, 9 or 10.

### NOTES

**Power Cab systems DO NOT poll addresses 6 or 7.**

**A Power Cab MASTER can ONLY be address 2, 3, 4 or 5.**

**Address 0 is the broadcast address, which is not assigned to any device, and Address 1 is reserved.**

**Power Cab CAB 5 is only available with firmware 1.65.**

## 6.2 - Factory Reset

If you deliberately set the Super Panel CAB address to **ZERO**, a **Factory Reset** takes place. This sets all the default values including setting the Super Panel address to 10. A factory reset also erases the input command areas to factory settings, which is an End command in step 1 and NOOP commands in steps 2-20. The factory reset takes place upon the next hard reset or power-on. This allows you to change your mind and cancel the factory reset by setting the CAB address to non-zero before resetting.

Set the CAB Bus Address to 0, by pressing **0**:

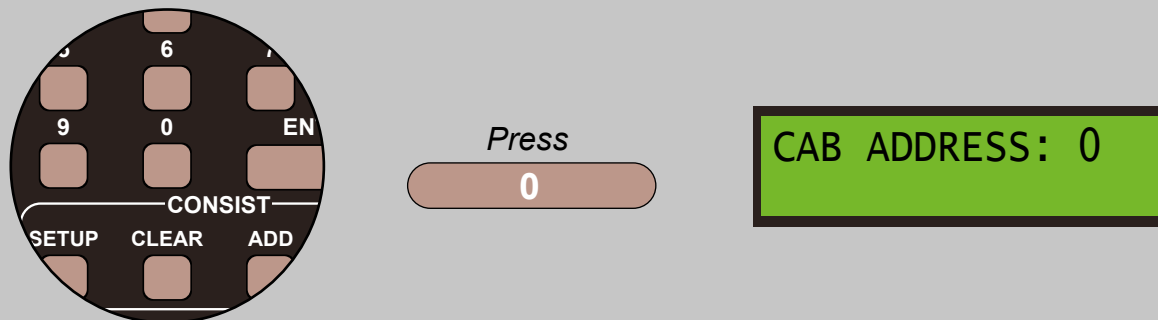

**Please note, a factory reset takes a long time!**

## 6.3 - Reserve Any Inputs Which Are Not Going To Be Used

This is an optional configuration item. To clarify the term, an 'unused input' is one where there is either no switch connected to it, or there is a sensor switch connected but no commands are going to be executed as a result of a change of state of the input. If there are going to be some inputs in this category, you can reserve them by setting the **UNUSED INPUTS** value to the first of those inputs, which would logically be at the high end of the number range, i.e. if the top 6 inputs are not going to be used to generate commands, set the **UNUSED INPUT** value as **42**, so that **42** to **47** are not scanned. Note, you can use the command area of reserved/unused inputs to extend the command space of the inputs that are not reserved. A value of ZERO disables this function, the default situation.

Connect the unit, the **START SCREEN** will appear, press **ENTER** to move to the **Main Menu**:

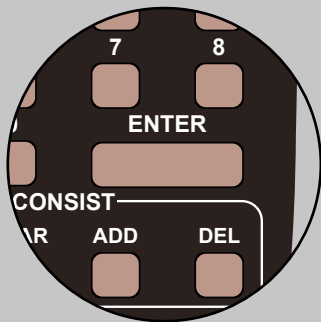

Start Screen

DCC CONCEPTS V1.  
SUPER PANEL 025B

Press

ENTER

1=SETUP 2=REVIEW  
3=TEST OPERATION

Select **1=SETUP** by pressing **1**, and then **2=SET CONFIG** by pressing **2**:

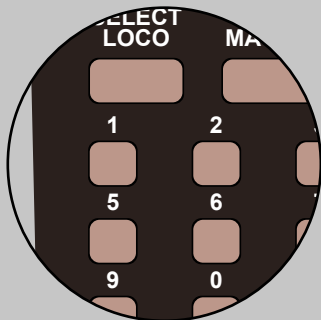

Press

1

THEN

Press

2

1=SETUP INPUT  
2=SETUP CONFIG

1=CAB ADDRESS >  
2=UNUSED INPUTS>

Select **2=UNUSED INPUTS** by pressing **2**:

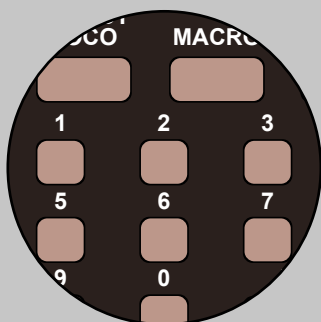

Press

2

UNUSED INPUTS  
FROM: 48 MODE:0

Select **4** and **0** to reserve all inputs from **40** to **47**:

UNUSED INPUTS  
FROM: 40 MODE:0

Confirm your choice by pressing **ENTER**, then press **PROG/ESC** twice to return to the **MAIN MENU**:

An *'unused input'* never executes commands when its state changes. Its commands can be edited, reviewed and tested as for any input, and an *'unused input'* can be subject of a *'link'* command or an *'activate'* command.

**Please note - entering input number 1 to the to the unused inputs screen will effectively disable all inputs for commands execution.**

Two mode are available:

**Mode 0** - means that unused inputs are **NOT** scanned and their states are **NOT** stored internally, so they are effectively ignored. This is the same as the NCE's Mini Panel.

**Mode 1** - means that unused inputs **ARE** scanned and their states **ARE** stored internally, but they do not execute commands as a result of a change in state. This mode can be used in conjunction with block detectors or other sensor switches where you want to test the input states with **WAIT** and **SKIP** commands but you do no want any command execution from the input themselves.

Select **MODE 0** or **1** by pressing **DIRECTION**

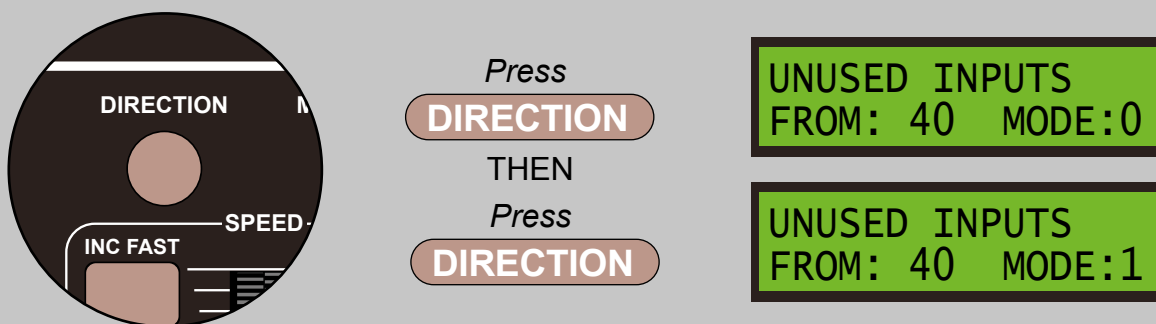

Confirm your choice by pressing **ENTER**, then press **PROG/ESC** twice to return to the **MAIN MENU**.

A real-world example is where inputs 1 to 32 are connected to switches on a control panel, and inputs 33 to 40 are connected to sensors. Inputs 1 to 32 generate actions when their states change but inputs 33 to 40 do not. From this, commands streams within the 1 to 32 range use **SKIP** and **WAIT** commands to test the states of the sensor inputs 33 to 40. The *'unused input'* value is set to 33 and the *'mode'* is set to 1 so that the states of the sensors inputs are scanned and stored internally.

Please note, if you **DO** want sensor inputs to generate command actions directly, i.e. changing signal or level crossing lights, those inputs must **NOT** be within the unused range.

The command areas of Unused Inputs can be used as extensions to other inputs or they can be used in their own right.

## 6.4 - Allocate An Input To Interrupt *WAIT* States Or *HOLD* Command Execution

If you program a sequence on one input which waits for another input to change, you may get a situation where the Super Panel waits forever if the waited for condition does not occur.

Connecting an input to a push-button switch and allocating it to the wait-interrupt function allows you to get out of this situation without resetting the Super Panel.

Alternatively, you are running an automation command sequence and you want to stop commands being executed temporarily while you intervene manually in some way. Connecting an input to a toggle switch and allocating it to the command hold function allows you to do this. When the hold function is activated, all command and input timer processing is suspended, and will remain suspended until the switch is turned off - commands may be queued during the '*hold*' period.

In either case, the chosen input must be **BELOW** the range reserved as unused inputs. The command area of the wait/hold input is not used so you can use it to extend the command area of the non-reserved input.

The wait interrupt function cancels the wait function on all inputs that have a wait pending and therefore applies to all the Super Panel inputs.

The hold function stops all timers related to inputs so if an input is running a command sequence which flashes an LED, that will stop while the hold is active.

A zero value disables this function, this is the default setting.

Connect the unit, the **START SCREEN** will appear, press **ENTER** to move to the **Main Menu**:

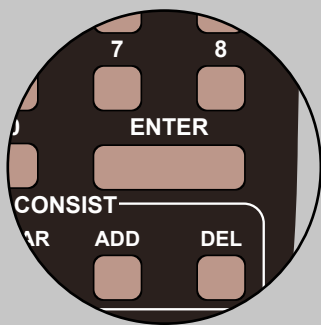

Start Screen

Press

ENTER

DCC CONCEPTS V1.  
SUPER PANEL 025B

1=SETUP 2=REVIEW  
3=TEST OPERATION

Select **1=SETUP** by pressing **1**, and then **2=SET CONFIG** by pressing **2**:

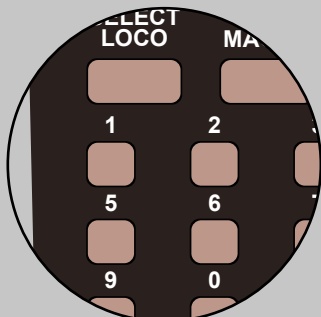

Press

1

THEN

Press

2

1=SETUP INPUT  
2=SETUP CONFIG

1=CAB ADDRESS >  
2=UNUSED INPUTS>

Select **3=HOLD/WAIT INT** by pressing **3**:

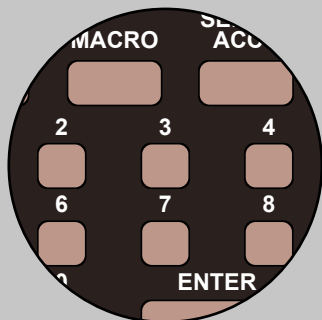

Press

**3**

The screen then shows this:

3=HOLD/WAIT INT>  
4=HI PROG CAB AD

HOLD/WAIT : WAIT  
INPUT: 0

Enter a number for the input from 1 to 47, or 1 less than the lowest unused input if there are unused inputs.

Select **WAIT** or **HOLD** by pressing **DIRECTION**:



Press

**DIRECTION**

THEN

Press

**DIRECTION**

HOLD/WAIT : WAIT  
INPUT: 0

HOLD/WAIT : HOLD  
INPUT: 0

Confirm your choice by pressing **ENTER**, then press **PROG/ESC** twice to return to the **MAIN MENU**:

## 6.5 - Set The Highest Address That The Super Panel Will Poll To Find A Programming CAB

When searching for a programming CAB, the Super Panel will poll addresses from 2 to 'N' at a rate of 8 polls per second. If 'N' was 63, it could take up to 7.5 seconds for a programming CAB to be discovered. By default, the Super Panel limits its scan for a programming CAB to addresses 2 to 10, as this speeds up the discovery process. If you want to connect a ProCab with an address higher than 10, enter the new address and press enter to store it.

Connect the unit, the **START SCREEN** will appear, press **ENTER** to move to the **Main Menu**:

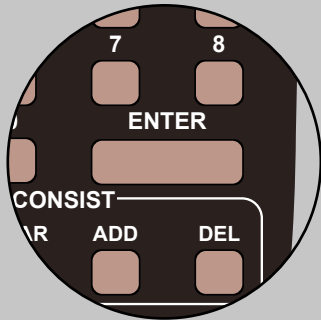

Start Screen

DCC CONCEPTS V1.  
SUPER PANEL 025B

Press

ENTER

1=SETUP 2=REVIEW  
3=TEST OPERATION

Select **1=SETUP** by pressing **1**, and then **2=SET CONFIG** by pressing **2**:

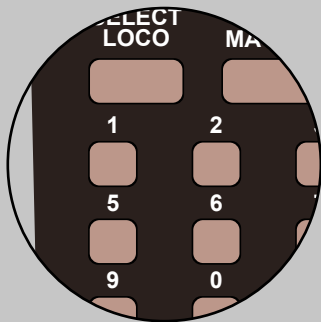

Press

1

THEN

Press

2

1=SETUP INPUT  
2=SETUP CONFIG

1=CAB ADDRESS >  
2=UNUSED INPUTS>

Select **4=HI PROG CAB AD** by pressing **4**:

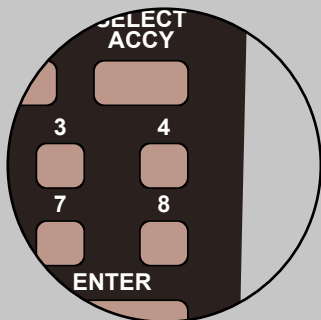

Press

4

The screen then  
shows this:

4=HI PROG CAB AD  
5=OUTPUT SELECT>

HIGH PROG CAB  
ADDRESS: 10

Setting address **20** by pressing **2** and **0**:

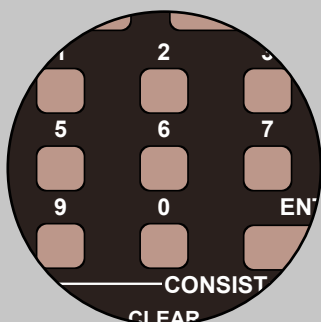

Press

2 then 0

HIGH PROG CAB  
ADDRESS: 20

Confirm your choice by pressing **ENTER**, then press **PROG/ESC** twice to return to the **MAIN MENU**:

## 6.6 - Select Inputs As Outputs

This option allows you to change a group of inputs at the high end of the input range from inputs to outputs. Those outputs may then be used to directly drive LEDs or other low-current devices, up to a current of 20mA maximum. *Note - these outputs are not strong enough to drive a relay coil directly.*

Connect the unit, the **START SCREEN** will appear, press **ENTER** to move to the **Main Menu**:

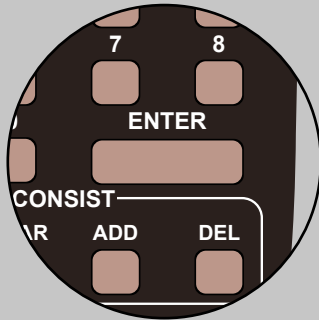

Start Screen

Press

ENTER

DCC CONCEPTS V1.  
SUPER PANEL 025B

1=SETUP 2=REVIEW  
3=TEST OPERATION

Select **1=SETUP** by pressing **1**, and then **2=SET CONFIG** by pressing **2**:

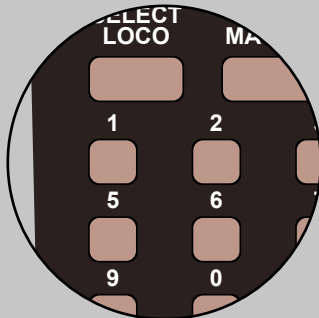

Press

1

THEN

Press

2

1=SETUP INPUT  
2=SETUP CONFIG

1=CAB ADDRESS >  
2=UNUSED INPUTS>

Select **5=OUTPUT SELECT** by pressing **5**:

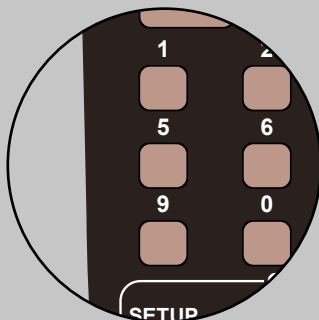

Press

5

The screen then  
shows this:

5=OUTPUT SELECT>  
6=LED MODE SEL >

SELECT OUTPUTS  
FROM: 48

Select address **45** by pressing **4** and **5**:

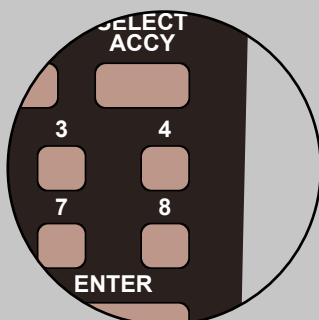

Press

4 then 5

SELECT OUTPUTS  
FROM: 45

Confirm your choice by pressing **ENTER**, then press **PROG/ESC** twice to return to the **MAIN MENU**:

The number you enter here is the number of the lowest pin that is to be used as an output. Outputs are always at the top end of the pin range, i.e. from 47 downwards. Enter the number required, then press ENTER. A value of 0 for outputs disables this feature and all pins are re-configured as inputs.

The 3 pseudo inputs 48, 49, 50 may be set as outputs independently of the physical inputs so that programs can set and clear them as logical flags. The above display may therefore initially show 48 until changed by manual input. Entering 0 will change the pseudo inputs to input mode and you then won't be able to change their logical state. If you want to remove all physical outputs but keep the pseudo inputs as flags, enter value 48.

Output pins are incompatible with inputs, so regardless of whether any inputs have been reserved as unused or not, **see 6.3 Reserve Any Inputs Which Are Not Going To Be Used**, inputs are automatically reserved to match outputs. If some inputs have already been reserved and the lowest unused input is above that of the lowest output as chosen above, the lowest unused input is reduced to match.

Note that if you define some outputs, say 44, to make 44 to 47 outputs, and you subsequently take some or all of them away, by entering say 46, or 48 for pseudo inputs only, or even 0 to disable them all, you will have to adjust the Unused Inputs setting manually if you want the physical inputs to be active again.

If a 'wait interrupt' or 'command hold' input has been defined already, it must lie outside the range of the unused input range, meaning it must be below the lowest unused input. Unused Input and Output pins are not scanned for changes so to have this input within this range would be meaningless.

To give an example, it is permissible to have the top 10 inputs unused, 38-47, and then have the top 5 inputs as outputs, 43-47. It is not permissible to have more outputs than unused inputs. A 'wait interrupt' or 'command hold' input can be assigned to any of the normal inputs 1-37, but not in the range 38-47.

The command areas for pins designated as outputs remain usable and editable but they will not be activated by changes in the pin output states. Commands stored for these pins can be activated via the 'test' function, or 'link' or 'activate' commands. They can also be activated at start-of-day and a good example of this is where an LED is attached to an output, say 47, and the same command area is used to flash the LED as a heartbeat indicator. **See section 12, The Start-Of-Day Initialisation Feature for more details.**

Selecting a group of pins to act as outputs automatically creates entries in the start-of-day initialisation table, assuming the auto-addition mode is enabled. By default, all the pins are driven high when the start-of-day initialisation process runs, so as to turn off any locally-connected LEDs. This only applies to common anode LEDs, common cathode LEDs, such as Alpha Mimic LEDs, will be turned on. The user can update this situation, to remove the initialisation entries or make them drive low, via the top-level start-of-day initialisation review and update menu.

## 6.7 - Setting The Mode Of The On-Board LED

From new, the Super Panel will flash the on-board LED on and off at one second intervals to act as a 'heartbeat', to show that the unit is running successfully. The alternative is to have the LED flash whenever an 'input action' is transmitted to the command station. You will then get a short flash to show control panel activity.

Mode 0 = Heartbeat slow flash - default mode.

Mode 1 = Operational activity

Connect the unit, the **START SCREEN** will appear, press **ENTER** to move to the **Main Menu**:

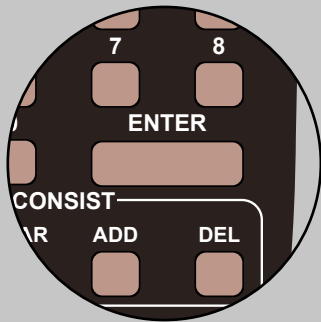

Start Screen

DCC CONCEPTS V1.  
SUPER PANEL 025B

Press

ENTER

1=SETUP 2=REVIEW  
3=TEST OPERATION

Select **1=SETUP** by pressing **1**, and then **2=SET CONFIG** by pressing **2**:

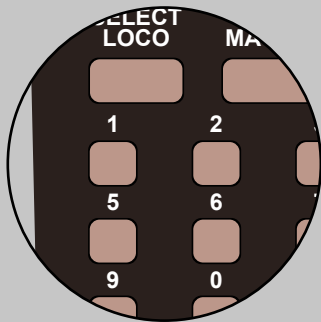

Press

1

THEN

Press

2

1=SETUP INPUT  
2=SETUP CONFIG

1=CAB ADDRESS >  
2=UNUSED INPUTS>

Select **6=LED MODE SEL** by pressing **6**:

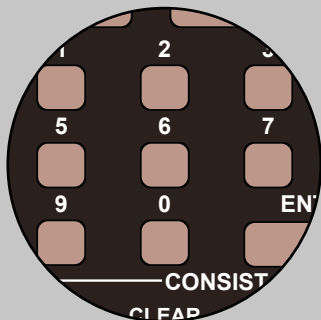

Press

6

6=LED MODE SEL >  
7=INPUT MONITOR>

The screen then  
shows this:

SET LED MODE  
0=REGULAR H'BEAT

Select **0** for the 'heartbeat' mode and **1** for the active input mode.

SET LED MODE  
0=REGULAR H'BEAT

SET LED MODE  
1=ACTIVE TRANSMT

Confirm the selection by pressing **ENTER**, and then press **PROG/ESC** twice to return to the **Main Menu**.

You can connect an external LED to the LED ONLY connection on the Super Panel board. This can be mounted on the fascia of your control panel and works in parallel with the on-board LED.

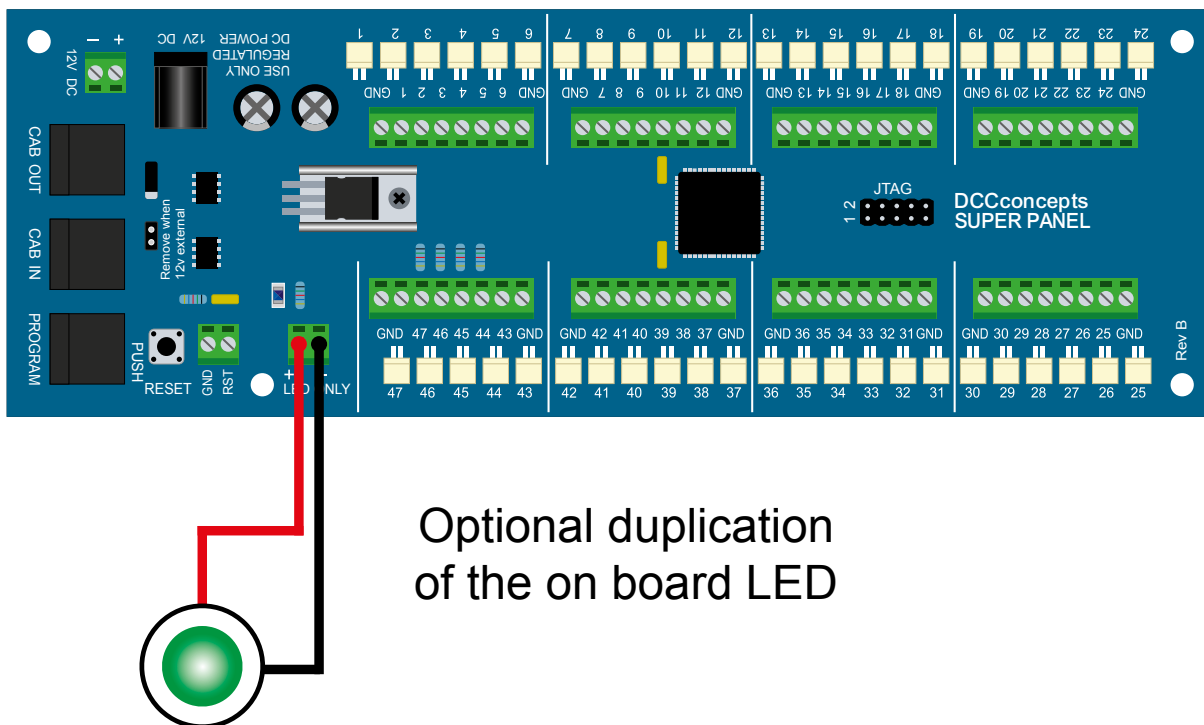

Optional duplication of the on board LED

**Note:**

The on board LED will double flash when the Super Panel has no CAB bus attached to it. It will also do the same when first powered up and you have no controller connected to the program port either. If you connect either a handset to the program port, or a cable from your NCE command station to the **CAB IN** or **CAB OUT** connection, the LED will resort to single flashes.

## 6.8 - Set An Input To Be Monitored By The On-Board LED

The Super Panel has a feature which allows you to monitor the state of any input which is not necessarily connected to a switch i.e. a block detector or other sensor whose own indicator may not be visible. This feature is intended for use during the testing of the detectors but it may be left active permanently if required. The setting is remembered when the system is powered off. This setting overrides the setting of the on-board LED that was set in the previous section.

Connect the unit, the **START SCREEN** will appear, press **ENTER** to move to the **Main Menu**:

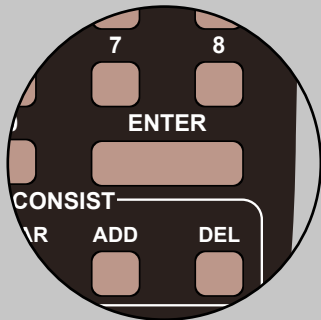

Start Screen

DCC CONCEPTS V1.  
SUPER PANEL 025B

Press

ENTER

1=SETUP 2=REVIEW  
3=TEST OPERATION

Select **1=SETUP** by pressing **1**, and then **2=SET CONFIG** by pressing **2**:

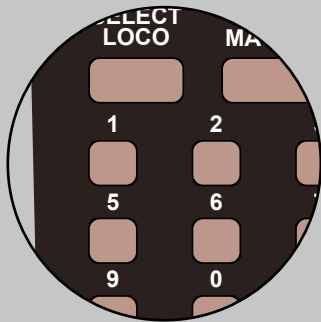

Press

1

THEN

Press

2

1=SETUP INPUT  
2=SETUP CONFIG

1=CAB ADDRESS >  
2=UNUSED INPUTS>

Select **7=INPUT MONITOR** by pressing **7**:

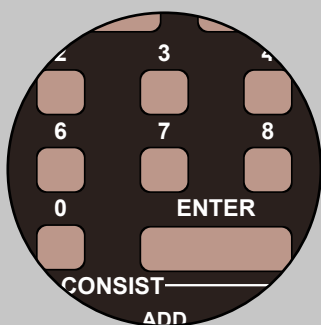

Press

7

The screen then  
shows this:

7=INPUT MONITOR>  
8=INIT MODE SEL

SETUP MONITOR OF  
INPUT: 00

Enter the number of the input or output you want to monitor, in this case **1** and **0**, and then press **ENTER** to store this. Enter **0** twice to disable this feature.

SETUP MONITOR OF  
INPUT: 10

The on-board LED will be lit when the input or output is **LOW/ACTIVE**, and unlit when **HIGH/INACTIVE**. The input must be low for a minimum of 1/8th second, 125 milliseconds, for the monitor to see it, and the LED will then be lit for the same minimum period.

## 6.9 - Set The Start-Of-Day Initialisation Mode

From the box, the Super Panel's start-of-day initialisation process is **ACTIVE**. When the process is active, responses are sent to the command station for every entry present in the initialisation table, so as to align turnouts with switches i.e. toggle switches. Inputs are automatically entered into the table when commands are present in both **LOW** and **HIGH** commands sets, implying that those inputs are connected to switches with two meaningful states, i.e. **ON** or **OFF**.

The initialisation process is delayed by 3 seconds after power-up **AND** the command station has been detected as ready to receive responses.

The initialisation mode parameter consists of two separate bits:

Bit 0 controls whether the initialisation process runs or not, hence:

**Bit 0=0 - disables the process**

**Bit 0=1 - enables the process**

Bit 1 controls whether or not an input is automatically added to the initialisation table during the command entry, when its is detected that command now exists in both **LOW** and **HIGH** commands sets, hence:

**Bit 1=0 - disables this function**

**Bit 1=1 - enables this function**

The default state is bits 0 and 1 are set to 1, which means a value of 3. Thus value 1 enables the initialisation process and value 2 enables the automatic addition into the table. Value 3 enables both function, the default value, and value 0 disables both functions.

Connect the unit, the **START SCREEN** will appear, press **ENTER** to move to the **Main Menu**:

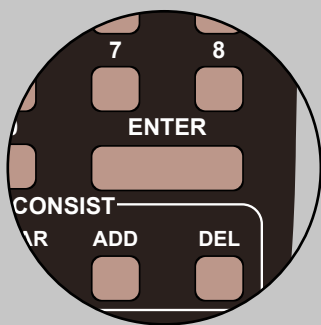

Start Screen

DCC CONCEPTS V1.  
SUPER PANEL 025B

Press

ENTER

1=SETUP 2=REVIEW  
3=TEST OPERATION

Select **1=SETUP** by pressing **1**, and then **2=SET CONFIG** by pressing **2**:

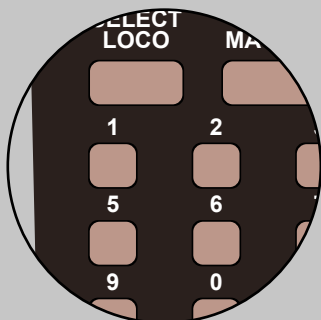

Press

1

THEN

Press

2

1=SETUP INPUT  
2=SETUP CONFIG

1=CAB ADDRESS >  
2=UNUSED INPUTS>

Select **8=INIT MODE SEL** by pressing **8**:

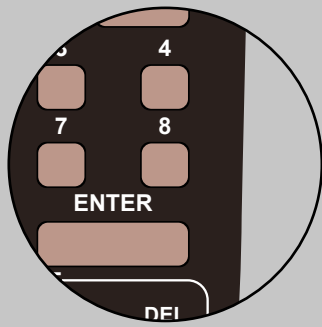

Press

8

The screen then shows this:

```
8=INIT MODE SEL
9=SET INIT DELAY
```

```
SET INIT MODE:3
MODE: (0,1,2,3)
```

Select **1** change the mode by pressing **1**:

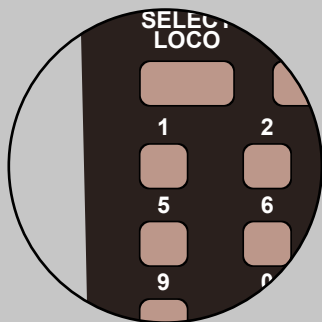

Press

1

```
SET INIT MODE:1
MODE: (0,1,2,3)
```

Confirm your choice by pressing **ENTER**, then press **PROG/ESC** twice to return to the **MAIN MENU**.

Please note that turning off bit 1 does not affect the manual addition of inputs into the initialisation table.

## 6.10 - Set The Start-Of-Day Initialisation Delay

From the box, the Super Panel starts its start-of-day initialisation process 3 seconds after it sees the command station is ready. When two or more Super Panels are in use on the same system, it is advisable for them not to send initialisation commands at the same time because to do so could overload the command station and commands could be missed.

This option allows you to change the delay factor in the second or additional Super Panels.

Connect the unit, the **START SCREEN** will appear, press **ENTER** to move to the **Main Menu**:

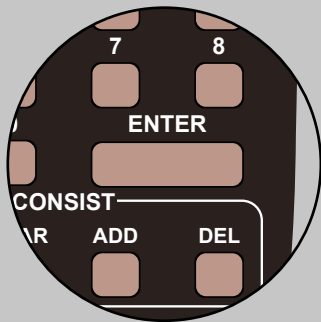

Start Screen

DCC CONCEPTS V1.  
SUPER PANEL 025B

Press

ENTER

1=SETUP 2=REVIEW  
3=TEST OPERATION

Select **1=SETUP** by pressing **1**, and then **2=SET CONFIG** by pressing **2**:

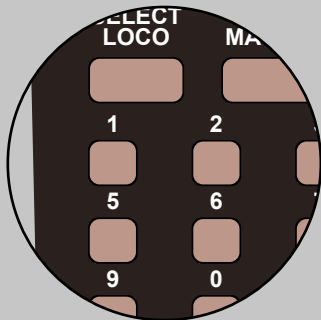

Press

1

THEN

Press

2

1=SETUP INPUT  
2=SETUP CONFIG

1=CAB ADDRESS >  
2=UNUSED INPUTS>

Select **9=SET INIT DELAY** by pressing **9**:

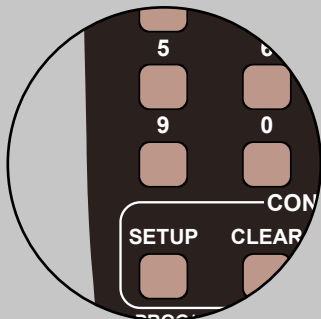

Press

9

The screen then  
shows this:

8=INIT MODE SEL  
9=SET INIT DELAY

SET START\_OF\_DAY  
INIT DELAY: 9

The current delay factor in seconds will be displayed on the second line. Enter a number between 1 and 63 and press **ENTER** to store.

For example with two Super Panels, with the first one controlling 30 points with initialisation enabled, the second Super Panel needs the delay to be set to a minimum of 9 seconds to avoid overlapping the commands sent by the first.

Select **9** change the mode by pressing **9**:

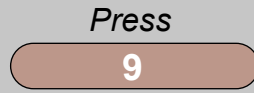
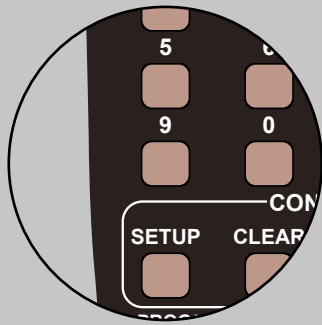

Confirm your choice by pressing **ENTER**, then press **PROG/ESC** twice to return to the **MAIN MENU**.

## 6.11 - Set the Command Post Action Delay

Two categories of commands, **Function Groups** and **CV-setting**, need to be spread out in real time so that the multiple copies of the commands that are sent out by the command station do not overlap and cause confusion. The command post-action delay automatically allows the **Function Groups** & **CV** commands sent on the DCC bus to complete before the next command is sent out.

Connect the unit, the **START SCREEN** will appear, press **ENTER** to move to the **Main Menu**:

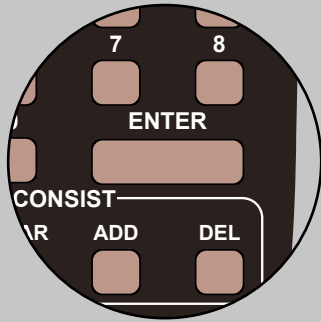

Start Screen

DCC CONCEPTS V1.  
SUPER PANEL 025B

Press

ENTER

1=SETUP 2=REVIEW  
3=TEST OPERATION

Select **1=SETUP** by pressing **1**, and then **2=SET CONFIG** by pressing **2**:

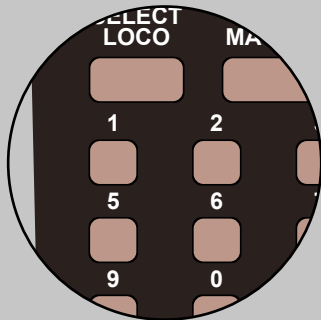

Press

1

THEN

Press

2

1=SETUP INPUT  
2=SETUP CONFIG

1=CAB ADDRESS >  
2=UNUSED INPUTS>

Select **0=SET POST COMMAND** by pressing **0**:

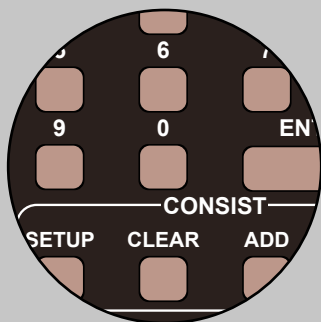

Press

0

The screen then  
shows this:

9=SET INIT DELAY  
0=SET CMD DELAY

SET POST COMMAND  
ACTION DELAY: 2

The delay count is in quarter seconds and the default value is 2. This means that successive Function Group or CV-setting commands will be delayed by between  $\frac{1}{2}$  and  $\frac{3}{4}$  of a second. Any other command following a Function Group or CV-setting command will not be delayed. For example, when a function group or CV command is actioned, it starts a timer. Any following function group or CV command will be delayed until the earlier command's timer expires, but other commands may be actioned without delay between the function group or CV commands.

To adjust this timer, enter a value between 1 and 7 and press **ENTER**, 2 or 3 is recommended. 1 will delay between  $\frac{1}{4}$  and  $\frac{1}{2}$  second, 2 will delay between  $\frac{1}{2}$  and  $\frac{3}{4}$  second and 3 will delay between  $\frac{3}{4}$  and 1 second.

Note that value 0 turns off the delay function but this is not recommended unless you only use single function group or CV commands in a sequence, or they are explicitly separated by **DELAY** commands of  $2 \times \frac{1}{4}$  seconds or more.

## 7 - Configuring Program Steps For Inputs

The sub-menus for the program steps are defined under **ACCESSORY**, **LOCO**, **SIGNAL** and **OTHER** functions.

```
INP:1  L STEP:1
1=ACCY 2=MACRO >
```

```
INP:1  L STEP:1
3=LOCO 4=SIGNAL>
```

```
INP:1  L STEP:1
5=OTHER 6=MORE>
```

```
INP:1  L STEP:1
9=EDIT 0=END
```

Connect the unit, the **START SCREEN** will appear, press **ENTER** to move to the **Main Menu**:

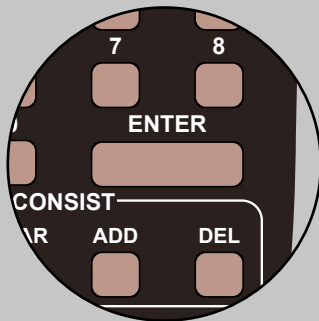

Start Screen

Press

**ENTER**

```
DCC CONCEPTS V1.
SUPER PANEL 025B
```

```
1=SETUP 2=REVIEW
3=TEST OPERATION
```

Select **1=SETUP** by pressing **1**, and then **1=SET INPUT** by pressing **1**:

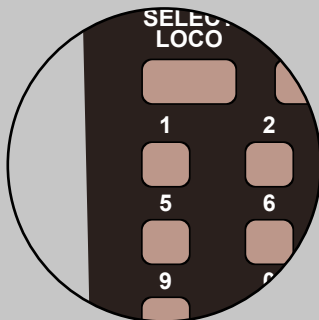

Press

**1**

THEN

Press

**1**

```
1=SETUP INPUT
2=SETUP CONFIG
```

```
SETUP INPUT MENU
INPUT:1 LO/HI:L
```

Enter the number of the input you want to set up or modify, and choose the **ACTIVE/LOW** or **INACTIVE/HIGH** command set. Press the **DIRECTION** button to toggle between **LOW** and **HIGH**.

```
SETUP INPUT MENU
INPUT:1 LO/HI:L
```

```
SETUP INPUT MENU
INPUT:1 LO/HI:H
```

There are two basic types of switches that you can connect to a Super Panel – toggle switches and push buttons.

Toggle switches can remain in one of two states – Open or Closed, while Push Buttons normally act only when pressed, Closed. Toggle switches are used to control points because they can be set

into either of two states – Normal or Reverse. Toggle switches therefore normally need commands entered into both the Low and High command sets so that actions occur when the switch is moved from one state to the other.

Push buttons on the other hand only need commands entered into the Low command set and the High command set is ignored – does nothing. Relays and block detectors can fit into either category, depending on your requirements. If a push button is used to control a powered uncoupling ramp, it may well need commands in the High command set so that the uncoupler is powered off when the button is released.

Select the step of the input you want to enter or modify. Press **ENTER** to accept and move to the next stage:

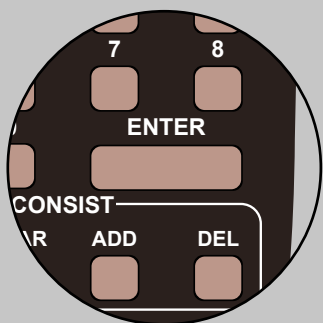

Press  
**ENTER**

```
INPUT:11 LOW
STEP: 1
```

Pressing **DIRECTION** will also toggle between **LOW** and **HIGH** at this point:

```
INPUT:11 LOW
STEP: 1
```

```
INPUT:1 HIGH
STEP: 1
```

Pressing **ENTER** will move to the sub menu. Pressing **DEC** will display the sub-menus for **ACCESSORY**, **LOCO**, **SIGNALS**, **OTHER** and **MORE** functions:

```
INP:1 L STEP:1
1=ACCY 2=MACRO >
```

```
INP:1 L STEP:1
3=LOCO 4=SIGNAL>
```

```
INP:1 L STEP:1
5=OTHER 6=MORE>
```

```
INP:1 L STEP:1
9=EDIT 0=END
```

At this point you can also press the **MACRO** key to toggle between the command entry, **SET UP INPUT**, and the command review, **REVIEW INPUT**

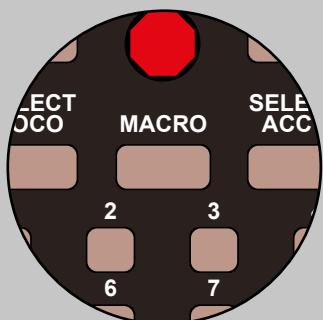

Press  
**MACRO**

THEN

Press  
**MACRO**

```
INP:1 L STEP:1
1=ACCY 2=MACRO >
```

```
INP:1 L STEP:1
ACCY:10 NORM
```

## Super Panel Commands

The Super Panel has commands to control the following types of devices:

1 - **ACCESSORY** - This could be a DCC point motor, i.e. DCC Concepts Cobalt iP Digital point motor, or an accessory decoder, i.e. DCC Concepts ADS-2SX decoder.

Please note you **CANNOT** control analogue point motors on their own, i.e. PECO, SEEP, etc.

2 - **MACRO** - Any macro that is defined and stored in the NCE command station.

3 - **LOCO** - Any loco that has a NMRA digital decoder installed. The sub menus are:

- 1 - **Loco#**
- 2 - **Speed**
- 3 - **Functions**
- 4 - **Momentum**
- 5 - **OPS CV Settings**

4 - **SIGNAL** - Control of any multi-signal DCC decoder.

5 - **OTHER** - Commands to work along side the controlled device. The sub menus are:

- 1 - **Delay**
- 2 - **Wait**
- 3 - **Link**
- 4 - **OPS CV**
- 5 - **Skip**
- 6 - **Jump**
- 7 - **Loco In Block**
- 8 - **Activate Input**
- 9 - **NOOP**
- 10 - **END CMD**

6 - **MORE** - Extended commands. The sub menus are:

- 1 - **Set Output Pin**
- 2 - **Cancel Input**
- 3 - **Set Register**
- 4 - **Add Register**
- 5 - **Skipif Reg=Val**
- 6 - **Waitif Reg=Val**
- 7 - **Copy Register**
- 0 - **END CMD**

9 - **EDIT** - Use to edit the command sequence, includes commands: The sub menus are:

- 1 - **Insert**
- 2 - **Delete**
- 3 - **Copy**
- 4 - **Erase**
- 5 - **Swap**

0 - **END** - Used to end the command sequence.

**We will now look at each of these in details.**

## 7.1 - ACCY - 1 = Accessory Number

The sub-menus for the program steps are shown below:

```
INP:1 L STEP:1
ACCY NUMBER:1
```

```
INP:1 L STEP:1
NORM/REV : N/1
```

```
INP:1 L STEP:1
NORM/REV : R/2
```

From the **INPUT COMMAND** screen press **1** to select the **ACCY** screen:

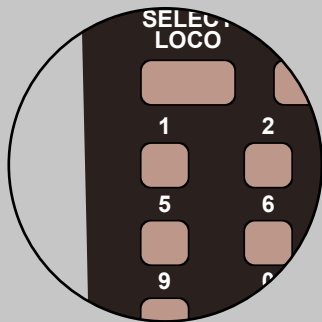

Input  
Command

```
INP:1 L STEP:1
1=ACCY 2=MACRO >
```

Press

1

```
INP:1 L STEP:1
ACCY NUMBER:1
```

Press **ENTER** to select the accessory number. Then select the **NORMAL** or **REVERSE** direction of the accessory by pressing **DIRECTION**, to toggle between the two or enter **1** for **NORMAL** or **2** for **REVERSE**.



Press

**DIRECTION**

THEN

Press

**DIRECTION**

```
INP:11 L STEP:1
NORM/REV : N/1
```

```
INP:1 L STEP:1
NORM/REV : R/2
```

Press **ENTER** to store the command and move to the next step:

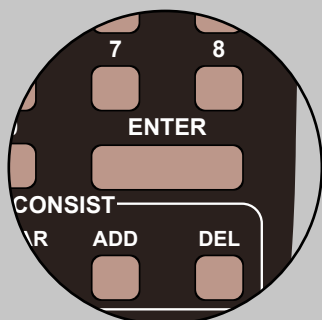

Press

**ENTER**

```
INP:1 L STEP:2
1=ACCY 2=MACRO >
```

If you press **ADD** instead of **ENTER**, the accessory command will automatically be duplicated in its reverse sense at the same command step in the opposite command set. This provides a short cut when entering accessory commands for a control panel when you want opposite actions for the two positions of a toggle switch. Enter the accessory number and normal/reverse in the **LOW** command set and use **ADD** instead of **ENTER** to add the reversed command in the **HIGH** command set, or vice versa.

When a point is driven by a solenoid motor, it is useful to add a short delay after an accessory command to give the decoder time to recharge its capacitor discharge unit.

There are occasions when you switch a point both ways in quick succession because you switched the wrong one by mistake, but adding a short delay after the accessory commands will avoid the second command, the 'switch back', being missed. The recommended delay is 4 to 6 quarter seconds, 1 to 1.5 seconds.

See the similar action in 7.5.1 for the **DELAY** command and 7.5.10 for the **END** command.

## 7.2 - MACRO - 2 = Macro Number

From the **INPUT COMMAND** screen press **2** to select the **MACRO** screen:

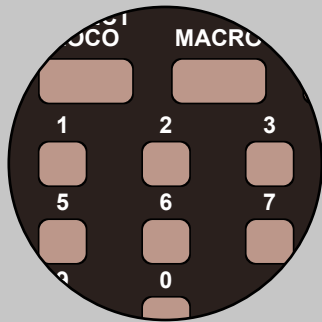

Input  
Command

Press

2

```
INP:1  L STEP:1  
1=ACCY 2=MACRO >
```

```
INP:1  L STEP:1  
MACRO NUM: 0
```

Press **1** and **0** to select the macro number 10. Press **ENTER** to store the command and move to the next step:

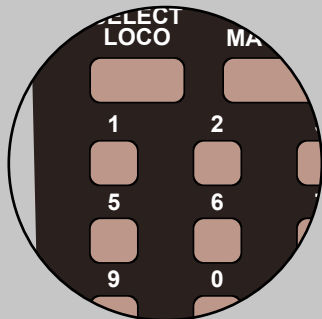

Press

1 then 0

THEN

Press

ENTER

```
INP:1  L STEP:1  
MACRO NUM: 10
```

```
INP:1  L STEP:2  
1=ACCY 2=MACRO >
```

The Macros themselves are defined and stored in the Command Station.

### 7.3 - LOCO - 3 = Locomotive Menus

This range of commands contains the following sub menus:

```
INP:1 L STEP:1  
1=LOCO# 2=SPEED
```

```
INP:1 L STEP:1  
3=FUNCTIONS >>
```

```
INP:1 L STEP:1  
4=MOMENTUM
```

```
INP:1 L STEP:1  
5=OPS CV SETTING
```

#### 7.3.1 - LOCO# - 1 = Locomotive Number

From the **INPUT COMMAND** screen press **3** to select the **LOCO** screen:

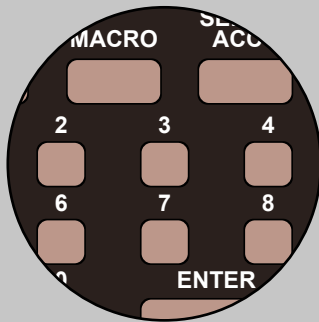

Input  
Command

Press

3

```
INP:1 L STEP:1  
1=ACCY 2=MACRO >
```

```
INP:1 L STEP:1  
1=LOCO# 2=SPEED
```

Select loco number sub menu **1** and then press **1** and **6** to select loco number 16:

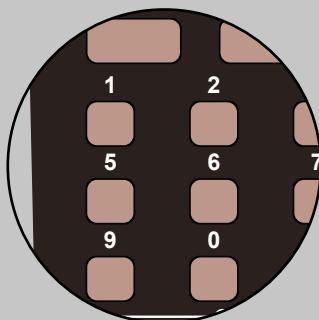

Press

1

THEN

Press

1 and 6

```
INP:1 L STEP:1  
LOCO NUM: 0
```

```
INP:1 L STEP:1  
LOCO NUM: 16
```

Press **ENTER** to store the command and move to the next step:

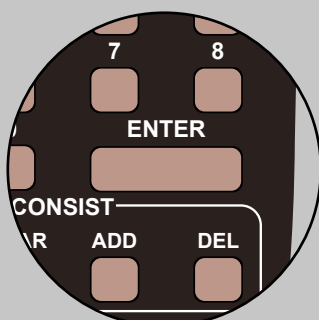

Press

ENTER

```
INP:1 L STEP:2  
1=LOCO# 2=SPEED
```

A **SHORT** loco address is entered as the number with no leading zero. It **MUST** be less than 127 to be a valid **SHORT** address. If you want to use a **LONG** address whose value is 127 or less, you **MUST** enter it with a leading zero.

**For example**            **Short Address 3, 34 or 121**  
                              **Long Address 01, 034 or 0121**

Loco address zero is treated as a special address. A '*long zero*' is a valid loco address whereas a '*short zero*' is the NMRA broadcast address. If you want to use the **SHORT** zero broadcast address, enter loco address with one zero digit. If you want to address the loco with the **LONG** address zero, enter the loco address with two or more zero digits.

**For example**            **Short Broadcast Zero Address 0**  
                              **Long Address 00**

### 7.3.2 - SPEED - 2 = Locomotive Speed

From the **INPUT COMMAND** screen press **3** to select the **SPEED** screen:

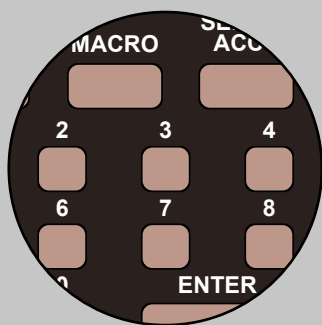

Input  
Command

Press

3

```
INP:1  L STEP:1  
1=ACCY 2=MACRO >
```

```
INP:1  L STEP:1  
1=LOCO# 2=SPEED
```

Select the **SPEED** sub menu by pressing **2**. To toggle the speed mode push **28/128** key:

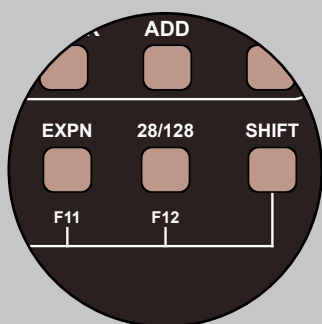

Press

2

THEN

Press

28/128

```
INP:1  L STEP:1  
SPD128: FWD:0
```

```
INP:1  L STEP:1  
SPD 28: FWD:0
```

For better control of the locomotive it is advisable to use 128 speed steps.

Set the direction by pressing **DIRECTION**:



Press

DIRECTION

THEN

Press

DIRECTION

```
INP:1  L STEP:1  
SPD128: FWD:0
```

```
INP:1  L STEP:1  
SPD128: REV:0
```

Set the loco speed value by entering 65, press **6** and then **5**:

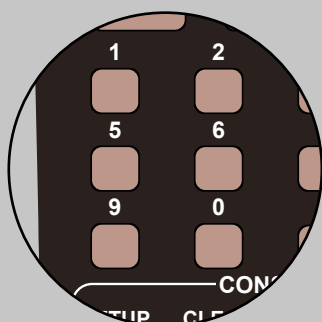

Press

6 then 5

THEN

Press

ENTER

```
INP:1  L STEP:1  
SPD128: FWD:65
```

```
INP:1  L STEP:2  
1=LOCO# 2=SPEED
```

It is recommended to use 128 mode as there is a bug in the handling of 28 mode in the NCE command station.

### 7.3.3 - FUNCTIONS - 3 = Locomotive Functions

This range of commands contains the following sub menus:

```
INP:1 L STEP:1
FUNC 04321 -----
```

Function Group 1

```
INP:1 L STEP:1
FUNC 8-5 -----
```

Function Group 2

```
INP:1 L STEP:1
FUNC 12-9 -----
```

Function Group 3

```
INP:1 L STEP:1
FN20-13 -----
```

Function Group 4

```
INP:1 L STEP:1
FN28-21 -----
```

Function Group 5

With the required function group displayed on line 2, press the number according to the table below.

#### Function Group Data Input:

The Loco Function Groups consist of groups of bits which are transmitted together to the selected locomotive. When entering the command steps for function groups, the table below shows how the keys on the ProCab map to the bits in the function groups. Keys 0 to 8 logically control functions F0 to F8, but for function groups 3, 4 and 5, keys 1 to 8 are used for commonality and in order to use single key presses. In all cases, pressing the same key twice toggles the corresponding function bit **ON** or **OFF**.

Apart from function group 1, the lowest numbered bit in each group is on the right and the highest on the left. When entering, or reviewing, a function group command step, bits which are **OFF** are displayed as '-' and bits that are **ON** are displayed as '1'.

GROUP	Bit 2 <sup>7</sup>	Bit 2 <sup>6</sup>	Bit 2 <sup>5</sup>	Bit 2 <sup>4</sup>	Bit 2 <sup>3</sup>	Bit 2 <sup>2</sup>	Bit 2 <sup>1</sup>	Bit 2 <sup>0</sup>
Function Group 1				F0	F4	F3	F2	F1
ProCab Key				0	4	3	2	1
Function Group 2					F8	F7	F6	F5
ProCab Key					8	7	6	5
Function Group 3					F12	F11	F10	F9
ProCab Key					4	3	2	1
Function Group 4	F20	F19	F18	F17	F16	F15	F14	F13
ProCab Key	8	7	6	5	4	3	2	1
Function Group 5	F28	F27	F26	F25	F24	F23	F22	F21
ProCab Key	8	7	6	5	4	3	2	1

So to set Functions **F1, F3, F6, F11, F17, F19, F21** and **F25**, the screens would look like:

```
INP:1  L STEP:1  
FUNC 04321 --1-1
```

Function Group 1

```
INP:1  L STEP:1  
FUNC 8-5  --1-
```

Function Group 2

```
INP:1  L STEP:1  
FUNC 12-9  -1--
```

Function Group 3

```
INP:1  L STEP:1  
FN20-13 -1-1----
```

Function Group 4

```
INP:1  L STEP:1  
FN28-21 ---1---1
```

Function Group 5

### Entering Extended Range

Functions F0 to F8 are entered using the keypad as usual. To enter any extended functions, toggle to the screen required, as shown above, and use the keypad as listed below:

#### Function 12-9

- Function 9 - Press keypad button 1
- Function 10 - Press keypad button 2
- Function 11 - Press keypad button 3
- Function 12 - Press keypad button 4

#### Function 20-12

- Function 13 - Press keypad button 1
- Function 14 - Press keypad button 2
- Function 15 - Press keypad button 3
- Function 16 - Press keypad button 4
- Function 17 - Press keypad button 5
- Function 18 - Press keypad button 6
- Function 19 - Press keypad button 7
- Function 20 - Press keypad button 8

#### Function 28-21

- Function 21 - Press keypad button 1
- Function 22 - Press keypad button 2
- Function 23 - Press keypad button 3
- Function 24 - Press keypad button 4
- Function 25 - Press keypad button 5
- Function 26 - Press keypad button 6
- Function 27 - Press keypad button 7
- Function 28 - Press keypad button 8

### 7.3.4 - MOMENTUM - 4 = Locomotive Momentum

From the **INPUT COMMAND** screen press **3** to select the **LOCO** screen:

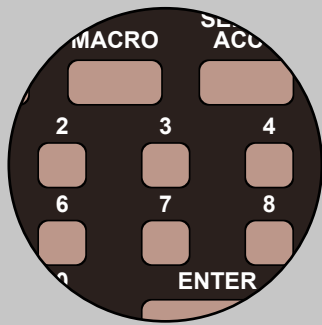

Input  
Command

Press

3

```
INP:1  L STEP:1  
1=ACCY 2=MACRO >
```

```
INP:1  L STEP:1  
1=LOCO# 2=SPEED
```

Select the **MOMENTUM** sub menu by pressing **4**. To set Momentum at 5, press **5** then **ENTER**:

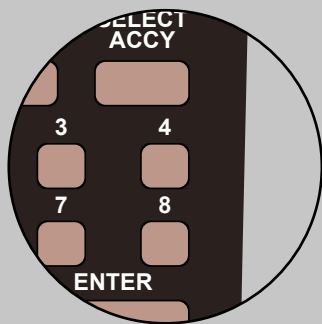

Press

4

THEN

Press

5

```
INP:1  L STEP:1  
MOMENTUM(0-9):0
```

```
INP:1  L STEP:1  
MOMENTUM(0-9):5
```

This sets the momentum for the locomotive. Values are from 0, momentum disabled, to 9, maximum momentum.

### 7.3.5 - LOCO OPS CV - 5 = Locomotive CV Settings

From the **INPUT COMMAND** screen press **3** to select the **LOCO** screen:

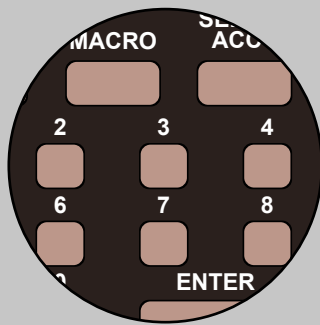

Input  
Command

Press

3

```
INP:1  L STEP:1  
1=ACCY 2=MACRO >
```

```
INP:1  L STEP:1  
1=LOCO# 2=SPEED
```

Select the **LOCO OPS CV** sub menu by pressing **5**. To change **CV27**, press **2** and then **7** then **ENTER**:

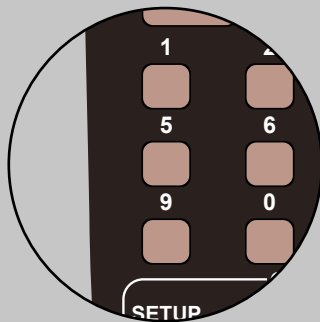

Press

5

THEN

Press

2 and 7

```
INP:1  L STEP:1  
OPS CV NUM: 1
```

```
INP:1  L STEP:1  
OPS CV NUM: 27
```

To enter CV value 50, press **5** and then **0** and press **ENTER** to store:

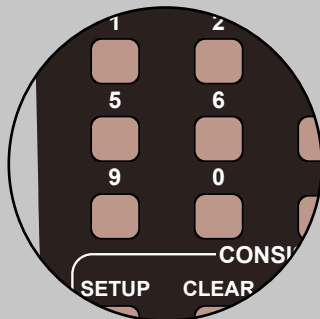

Press

5 and 0

THEN

Press

ENTER

```
INP:1  L STEP:1  
LOCO CV DATA:50
```

```
INP:1  L STEP:2  
1=ACCY 2=MACRO >
```

Please note this function is also available to change under the **OTHER** menu.

## 7.4 - SIGNAL - 4 = Signal Control

From the **INPUT COMMAND** screen press **4** to select the **SIGNAL** screen:

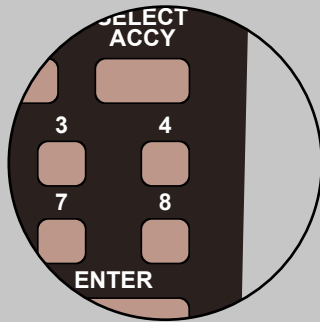

Input  
Command

```
INP:1  L STEP:1  
1=ACCY 2=MACRO >
```

Press

4

```
INP:1  L STEP:1  
SIGNAL: 1
```

Enter the signal number you want to control, in this case 2, press **2**, and enter the aspect number you want to send to, in this case 3, press **3** and then confirm by pressing **ENTER**:

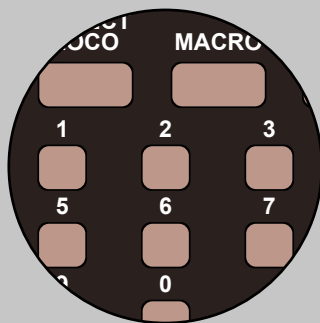

Press

2

THEN

Press

3

```
INP:1  L STEP:1  
SIGNAL: 2
```

```
INP:1  L STEP:1  
ASPECT: 3
```

Two command steps are entered automatically if the aspect number is greater than 7.

Note that NCE Light-It signal decoders accept aspect numbers 0 to 15 plus 30 and 31. Numbers 16 to 29 are meaningless for those decoders. Multi-Signal decoders action all aspects from 0 to 31, depending on mode.

## 7.5 - OTHER - 5 = Changes Various Values

This range of commands contains the following sub menus:

INP:1 L STEP:1 1=DELAY 2=WAIT >	INP:1 L STEP:1 3=LINK 4=OPS CV>	INP:1 L STEP:1 5=SKIP 6=JUMP >
INP:1 L STEP:1 7=LOCO IN BLOCK>	INP:1 L STEP:1 8=ACTIVATE INPUT	INP:1 L STEP:1 9=NOOP 0=END CMD

### 7.5.1 - DELAY - 1 = Delay Command

From the **INPUT COMMAND** screen press **3** to select the **OTHER** screen:

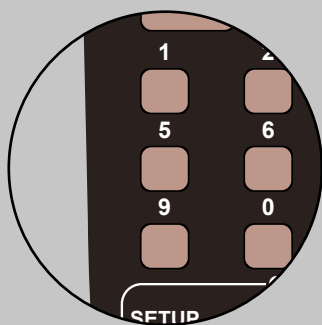

Input  
Command

Press

5

INP:1 L STEP:1  
1=ACCY 2=MACRO >

INP:1 L STEP:1  
1=DELAY 2=WAIT >

Select the **DELAY** sub menu by pressing **1**. To change between quarter seconds or 4 seconds press either **4** or **INC** or **DEC**, then press **ENTER** to store:

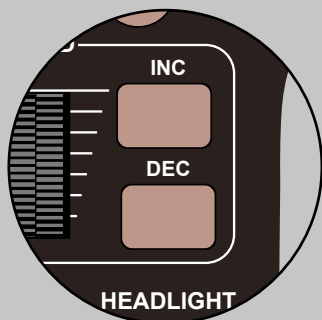

Press

1

THEN

Press

4 or INC or DEC

INP:1 L STEP:1  
DELAY QS/4S: Q

INP:1 L STEP:1  
DELAY QS/4S: 4

Enter the delay count, in this case either **1/2 a second**, **2 x 1/4**, or **8 seconds**, **2 x 4**, depending on the value selected on the previous screen, enter **2**, then press **ENTER** to store:

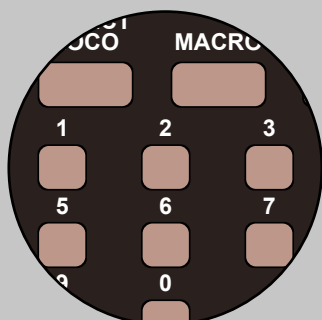

Press

2

OR

Press

2

INP:1 L STEP:1  
Q SEC COUNT: 2

INP:1 L STEP:1  
4 SEC COUNT: 2

If you press **ADD** instead of **ENTER**, the **DELAY** command will be duplicated at the same step in the opposite command set. See also section 7.1 for Accessory commands when you have solenoid-driven accessories.

## 7.5.2 - WAIT - 2 = Wait Command

From the **INPUT COMMAND** screen press **5** to select the **OTHER** screen:

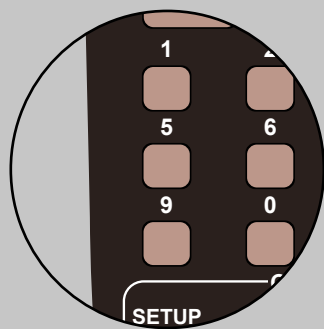

Input  
Command

Press

5

```
INP:1  L STEP:1  
1=ACCY 2=MACRO >
```

```
INP:1  L STEP:1  
1=DELAY 2=WAIT >
```

Select the **WAIT** sub menu by pressing **2**. Then select the input you want to wait for, press **1** and then **ENTER** store:

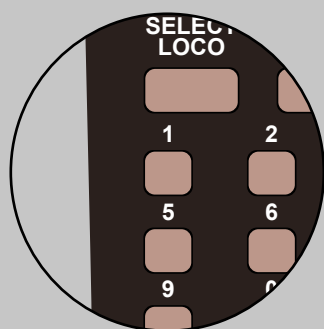

Press

1

THEN

Press

ENTER

```
INP:1  L STEP:1  
INPUT NUMBER: 1
```

```
INP:1  L STEP:1  
LOW/HIGH: L 1=C
```

There are three possible states when it comes to waiting for an input, these are:

- 1 - Active/LOW (L)
- 2 - Inactive/HIGH (H)
- 3 - Complete (C) meaning 'not busy'

Given that it is possible to activate an input as a secondary command stream, the command stream may well contain **DELAY** or other **WAIT** commands, such as waiting for a sensor input to change state. Such a command stream then takes time to complete and it remains busy until it does. The 'complete' option here allows this input to wait until the subject input has completed its commands.

It is valid to **WAIT** to test an input configured as an output. This also applies to the 3 pseudo inputs 48 to 50 when in output mode. However, an output never goes busy so it is meaningless to select the 'complete' state for an output.

Press **DIRECTION** to toggle between **Active/LOW** and **Inactive/HIGH** for that input.

Press the **1** key to toggle between **LOW/HIGH** and **C** for **COMPLETE**.

Press **ENTER** to store the command.

```
INP:1  L STEP:1  
LOW/HIGH: L 1=C
```

```
INP:1  L STEP:1  
LOW/HIGH: H 1=C
```

```
INP:1  L STEP:1  
LOW/HIGH: C 1=C
```

When a **WAIT** command is actioned at run-time, a 'complete' status request takes precedence over the **LOW** or **HIGH** physical state of the subject input.

## 7.5.3 - LINK - 3 = Link Command

From the **INPUT COMMAND** screen press **5** to select the **OTHER** screen:

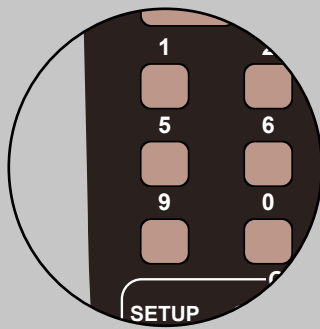

Input  
Command

```
INP:1  L STEP:1
1=ACCY 2=MACRO >
```

Press

5

```
INP:1  L STEP:1
1=DELAY 2=WAIT >
```

Select the **LINK** sub menu by pressing **3**. Then select the input you want to wait for, press **1** and then **ENTER** store:

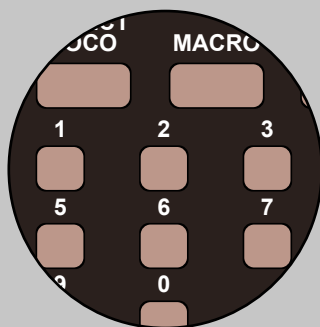

Press

3

```
INP:1  L STEP:1
INPUT NUMBER: 1
```

THEN

Press

1

```
INP:1  L STEP:1
LOW/HIGH: L
```

Press **DIRECTION** to toggle between **Active/LOW** and **Inactive/HIGH** for that input, and press **2** to toggle between **Step 1** and **Step 11**. Press **ENTER** to store the command.

```
INP:1  L STEP:1
LOW/HIGH: L
```

```
INP:1  L STEP:1
LOW/HIGH: H
```

```
INP:1  L STEP:1
LOW/HIGH: L >11
```

Press **DIRECTION** to toggle between **Active/LOW** and **Inactive/HIGH** command areas for that input. Command execution normally begins at **Step 1** in the selected area but it is possible to start execution at **Step 11**, meaning you can optionally use the 'second half' of an input which has 10 commands or less in the 'first half'. Any commands in the 'first half' of the input should be self-terminating with the last command being an **END**, **JUMP** or **LINK**. i.e. the commands in the 'first half' should not run into the 'second half' unless you want this to happen deliberately. To select a **LINK** to **Step 11** of the selected input, press the **2** key, which will toggle between step 1 and step 11.

The input number you choose here would normally be 'unused', so that its command area is free. You can use either the **LOW** command area or the **HIGH** area or link them together. You can link from the **LOW** command area to the **HIGH** command area of the same input, and vice versa, providing the input is in mode 1. See **Section 14** for more details of the input mode.

If you choose to link to an input that not 'unused', meaning it has commands that will be actioned by that input changing state, linking to it will inherently execute the commands that are present in the selected command area.

## 7.5.4 - OPS CV - 4 = Ops CV Command

From the **INPUT COMMAND** screen press **5** to select the **OTHER** screen:

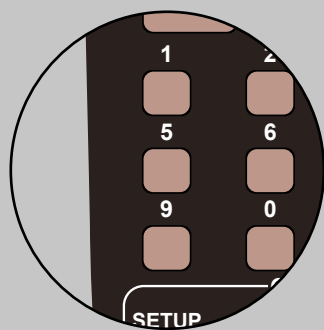

Input  
Command

```
INP:1  L STEP:1  
1=ACCY 2=MACRO >
```

Press

5

```
INP:1  L STEP:1  
1=DELAY 2=WAIT >
```

Select the **OPS CV** sub menu by pressing **4** and then select the CV number, press **ENTER**:

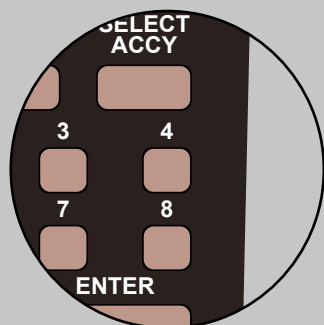

Press

4

```
INP:1  L STEP:1  
OPS CV NUM: 1
```

THEN

Press

ENTER

```
INP:1  L STEP:1  
LOCO CV DATA:00
```

Enter the CV data between 0 and 255 using the keypad. Press **ENTER** to store the command. Press either the **DEC** or **INC** keys to pick one of the 3 sub-menus, shown below:

```
INP:1  L STEP:1  
LOCO CV DATA:00
```

```
INP:1  L STEP:1  
ACCY CV DATA:00
```

```
INP:1  L STEP:1  
SGNL CV DATA:00
```

With the required sub-menu displayed, enter the required data between 0 and 255, and then press enter to save. Please note the **OPS CV** command automatically applies to the last defined **LOCO**, **ACCESSORY** or **SIGNAL** and so should be proceeded with a suitable **LOCO** selection, or an **ACCESSORY** or **SIGNAL** command.

## 7.5.5 - SKIP - 5 = Skip Command

From the **INPUT COMMAND** screen press **5** to select the **OTHER** screen:

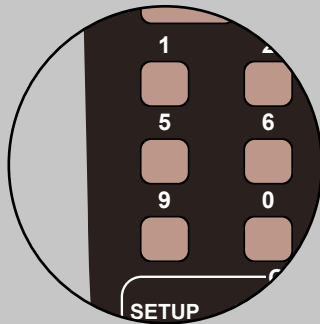

Input  
Command

```
INP:1  L STEP:1  
1=ACCY 2=MACRO >
```

Press

5

```
INP:1  L STEP:1  
1=DELAY 2=WAIT >
```

Select the **SKIP** sub menu by pressing **5** and then select the CV number, press **1**:

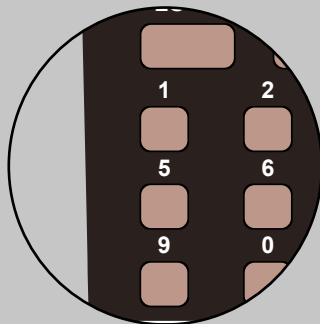

Press

5

```
INP:1  L STEP:1  
INPUT NUMBER: 1
```

THEN

Press

1

```
INP:1  L STEP:1  
LOW/HIGH: L 1=C
```

Press **DIRECTION** to toggle between **Active/LOW** and **Inactive/HIGH** for that input.

Press the **1** key to toggle between **LOW/HIGH** and **C** for **COMPLETE**.

Press **ENTER** to move to the next sub menu.

```
INP:1  L STEP:1  
LOW/HIGH: H 1=C
```

```
INP:1  L STEP:1  
LOW/HIGH: H 1=C
```

```
INP:1  L STEP:1  
LOW/HIGH: C 1=C
```

Enter the number of commands steps to skip using either **1, 2, 4** or **8** and press **ENTER**

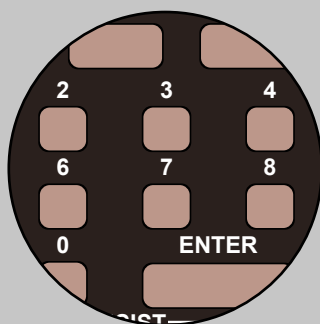

Press

1, 2, 4 or 8

```
INP:1  L STEP:1  
SKIP STEPS: 1
```

A **SKIP** command will skip over the designated number of steps if the selected input is in the designated state at the time the **SKIP** is executed. A **SKIP** command does not rely on a CHANGE of state of the subject input.

A skip may be placed at any step number up to 19, step 20 would be illogical. A skip is allowed to skip 'beyond the end' of the command list. For example, where you place a 'skip 1 step' at step number 19 and place a 'jump to step N' at step number 20. While the skip remains inactive, the jump executes a loop, but the skip becomes active, because the related input is in the required state, the skip action merely terminates the input command execution.

A skip may test the state of an input configured as an output, but may **NOT** use the 'complete' state as the test.

## 7.5.6 - JUMP - 6 = Jump Command

From the **INPUT COMMAND** screen press **5** to select the **OTHER** screen:

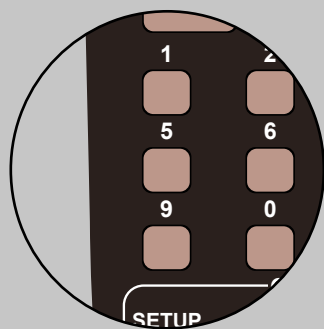

Input  
Command

Press

5

```
INP:1  L STEP:1  
1=ACCY 2=MACRO >
```

```
INP:1  L STEP:1  
1=DELAY 2=WAIT >
```

Select the **JUMP** sub menu by pressing **6** and then select the number of steps, using the keypad, you wish to jump and press **ENTER** to confirm your choice.

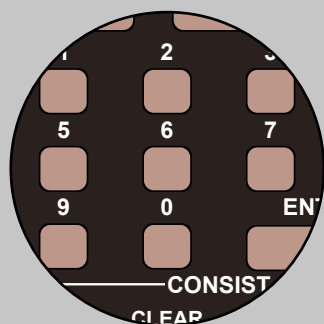

Press

KEYPAD

```
INP:1  L STEP:1  
JUMP TO STEP: 1
```

Please note that the **JUMPS** are unconditional and may well cause an infinite loop. It would be normal to construct a looping sequence with delays, so that actions occur at sensible intervals. It is also **STRONGLY** advised that you put a **SKIP** command in front of a **JUMP** that jumps 'backwards', so that you can skip over the **JUMP** when another input is activated, creating a 'break-out' mechanism. If you forget to provide a 'break-out' mechanism, the **ONLY** way to stop the loop is to overwrite the **JUMP** with another command, such as a **NO-OP**, no operation or **END** command.

**A last gasp option of breaking the loop is to unset the switch that initiates the loop and doing a hard reset of the Super Panel, losing all current activity on the other inputs!**

## 7.5.7 - LOCO IN BLOCK - 7 = Loco In Block Command

From the **INPUT COMMAND** screen press **5** to select the **OTHER** screen:

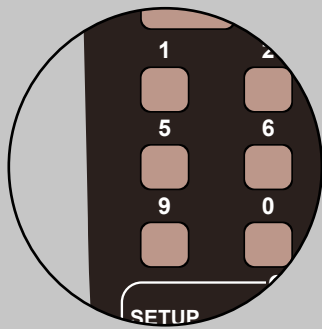

Input  
Command

Press

5

```
INP:1  L STEP:1  
1=ACCY 2=MACRO >
```

```
INP:1  L STEP:1  
1=DELAY 2=WAIT >
```

Select the **LOCO IN BLOCK** sub menu by pressing **7** and then select the block, using the keypad, and press **ENTER** to confirm your choice.

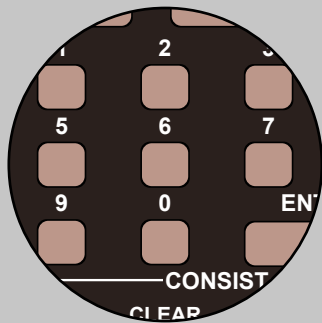

Press

KEYPAD

```
INP:1  L STEP:1  
BLOCK NUM: 1
```

This is where you would connect a block occupancy detector such as a Layout Concepts LM-iD or NCE BD20 to the input in question. Please note it is up to the command station or attached computer to interpret **LOCO IN BLOCK** indications at run-time.

## 7.5.8 - ACTIVATE ANOTHER INPUT - 8 = Active Another Input Command

From the **INPUT COMMAND** screen press **5** to select the **OTHER** screen:

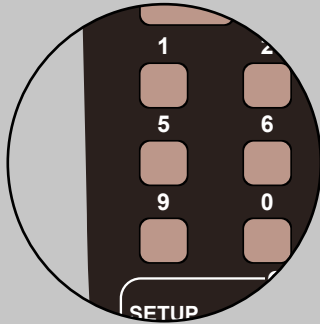

Input Command

Press

5

```
INP:1  L STEP:1  
1=ACCY 2=MACRO >
```

```
INP:1  L STEP:1  
1=DELAY 2=WAIT >
```

Select the **ACTIVATE ANOTHER INPUT** sub menu by pressing **8** and then select the **INPUT NUMBER** you wish to activate. Push the **DIRECTION** button to toggle between the **ACTIVE/LOW** or **INACTIVE/HIGH** commands sets, and press **ENTER** to confirm your choice.

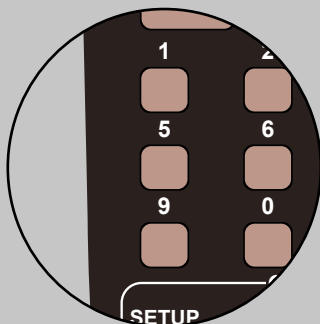

Press

5

THEN

Press

**DIRECTION**

```
INP:1  L STEP:1  
INPUT NUMBER: 1
```

```
INP:1  L STEP:1  
LOW/HIGH: L
```

The **ACTIVATE ANOTHER INPUT** command can be thought of as kind of a macro or subroutine in that you can run command streams in parallel with the current input. Once the subject input has been activated, akin to artificially changing the input state to low or high, the source input continues with its next command and does not wait for the subject input's command to complete.

The input being activated does not have to have a physical switch attached to it.

## 7.5.9 - NOOP - 9 = No Operation Command

From the **INPUT COMMAND** screen press **5** to select the **OTHER** screen:

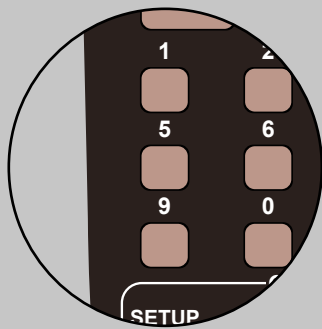

Input  
Command

```
INP:1  L STEP:1  
1=ACCY 2=MACRO >
```

Press

5

```
INP:1  L STEP:1  
1=DELAY 2=WAIT >
```

Select the **NOOP** sub menu by pressing **9** and press **ENTER** to confirm your choice.

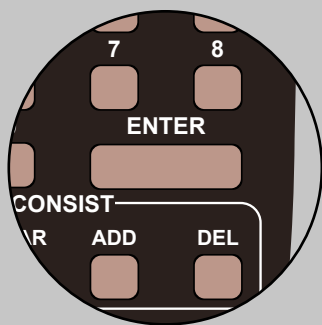

Press

ENTER

```
INP:1  L STEP:1  
NOOP:PRESS ENTER
```

If you press **ADD** instead of **ENTER**, the **NOOP** command will be duplicated at the same step in the opposite command set.

## 7.5.10 - END - 0 = End Command

From the **INPUT COMMAND** screen press **5** to select the **OTHER** screen:

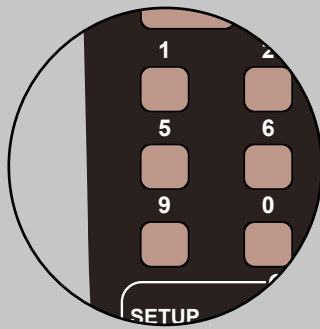

Input  
Command

```
INP:1  L STEP:1  
1=ACCY 2=MACRO >
```

Press

5

```
INP:1  L STEP:1  
1=DELAY 2=WAIT >
```

Select the **END CMD** sub menu by pressing **0** and press **ENTER** to confirm your choice. The **END** command terminates the sequence for the input's **LOW** or **HIGH** command stream.

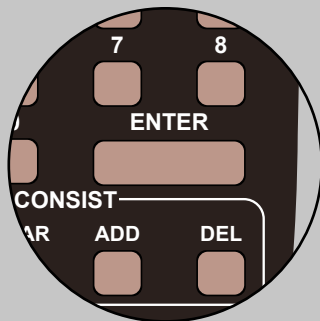

Press

ENTER

```
INP:1  L STEP:1  
END: PRESS ENTER
```

**END** commands terminate the sequence for the input's **LOW** or **HIGH** command stream.

If you press **ADD** instead of **ENTER**, the **NOOP** command will be duplicated at the same step in the opposite command stream. This is an adjunct to what happens if you press **ADD** to insert an accessory command, in that this is a short cut when entering commands for a control panel and you want to enter commands for both positions of a toggle switch without having to enter both sets of commands separately.

## 7.6 - MORE - 6 = Additional Commands

This range of commands contains the following sub menus:

INP:1 L STEP:1 1=SET OUTPUT PIN	INP:1 L STEP:1 2=CANCEL INPUT >	INP:1 L STEP:1 3=SET REGISTER >
INP:1 L STEP:1 4=ADD REGISTER >	INP:1 L STEP:1 5=SKIPIF REG=VAL	INP:1 L STEP:1 6=WAITIF REG=VAL
INP:1 L STEP:1 7=COPY REGISTER	INP:1 L STEP:1 0=END	

### 7.6.1 - SET OUTPUT PIN - 1 = Set Output Pin Command

From the **INPUT COMMAND** screen press **6** to select the **MORE** screen:

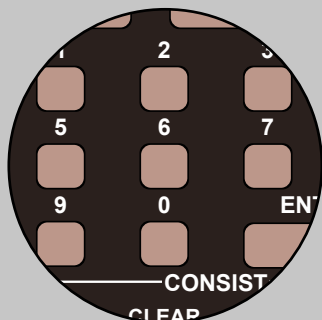

Input  
Command

Press

6

```
INP:1 L STEP:1  
1=ACCY 2=MACRO >
```

```
INP:1 L STEP:1  
1=SET OUTPUT PIN
```

Select the **SET OUTPUT PIN** sub menu by pressing **1**. Enter the output pin number using the keypad and press **ENTER** to confirm your choice.

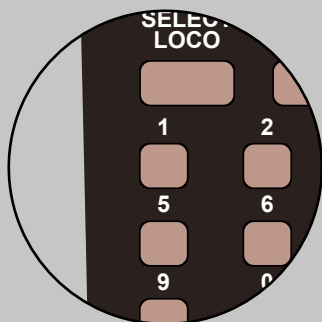

Press

1

THEN

Press

ENTER

```
INP:1 L STEP:1  
OUTPUT NUMBER:47
```

```
INP:1 L STEP:1  
LOW/HIGH: L
```

Press **DIRECTION** to toggle between **LOW** and **HIGH**, press **ENTER** to store your choice. An error will be displayed if the output number is not within the range of output puts or the outputs are not defined.

## 7.6.2 - CANCEL INPUT - 2 = Cancel Input Command

From the **INPUT COMMAND** screen press **6** to select the **MORE** screen:

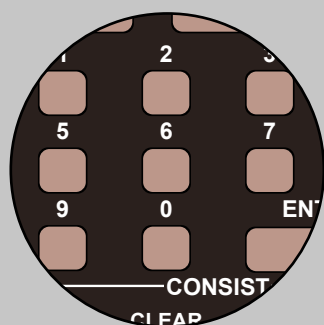

Input  
Command

```
INP:1  L STEP:1  
1=ACCY 2=MACRO >
```

Press

6

```
INP:1  L STEP:1  
1=SET OUTPUT PIN
```

Select the **CANCEL INPUT** sub menu by pressing **2**, select the input you wish to cancel using the **KEYPAD** and press **ENTER** to confirm your choice.

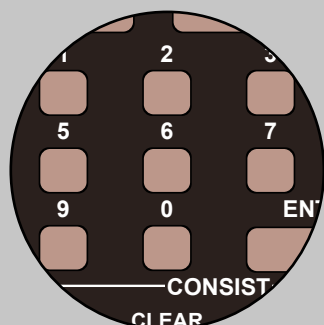

Press

KEYPAD

THEN

Press

ENTER

```
INP:1  L STEP:1  
INPUT NUMBER:47
```

```
INP:1  L STEP:1  
1=ACCY 2=MACRO >
```

This command cancels the actions of the selected input. This means any **WAIT** or **DELAY** command currently in progress on that input is terminated and any actions which would normally have taken place after the **WAIT** or **DELAY** do not happen. While it is most likely that this command will interrupt a **WAIT** or **DELAY**, it is also possible for this command to cancel the actions of the selected input between command steps. The result is the same i.e. the selected input becomes quiescent and the input must re-transition to the active state before any further actions take place from that input.

It is not permissible to have a series of actions, including **WAITS** and/or **DELAYS**, set up on the **ACTIVE/LOW** state of an input controlled by a toggle switch, and have the **INACTIVE/HIGH** state of the same input cancel the actions. This is because the **WAIT** or **DELAY** actions freeze the input state and the transition to **INACTIVE/HIGH** is not seen until all actions are complete.

If the series of actions on the selected input involves locomotive speed controls, i.e. one or more actions commanding the locomotive or locomotives to run, the locomotives continue to run when the actions are cancelled by this command. The locomotives would need to be stopped by other actions, possibly manually.

### 7.6.3 - SET REGISTER TO VALUE - 3 = Set Register Command

From the **INPUT COMMAND** screen press **6** to select the **MORE** screen:

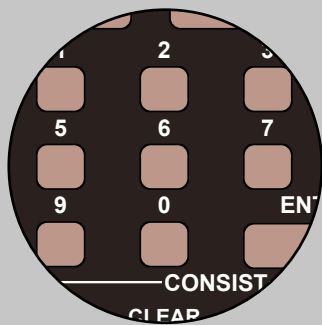

Input  
Command

```
INP:1  L STEP:1  
1=ACCY 2=MACRO >
```

Press

6

```
INP:1  L STEP:1  
1=SET OUTPUT PIN
```

Select the **SET REGISTER** sub menu by pressing **3**, select the register value you wish to change using the **KEYPAD**, then enter the value you wish using the **KEYPAD**, and press **ENTER** to confirm your choice.

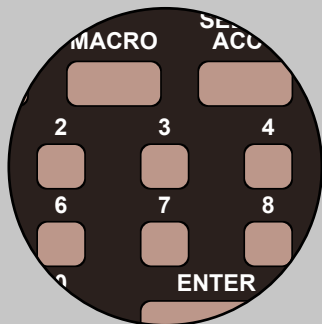

Press

3

```
INP:1  L STEP:1  
REGISTER NUM: 0
```

THEN

Press

1

```
INP:1  L STEP:1  
ENTER VALUE: 1
```

This command sets an internal user-level register to the value specified. The user registers are numbered 0 to 15 and the numerical values that these registers can hold is limited to 4 bits, i.e. 0 to 15. All the user registers are initialised to zero at power on or after a system reset.

## 7.6.4 - ADD VALUE TO REGISTER - 4 = Add To Register Command

From the **INPUT COMMAND** screen press **6** to select the **MORE** screen:

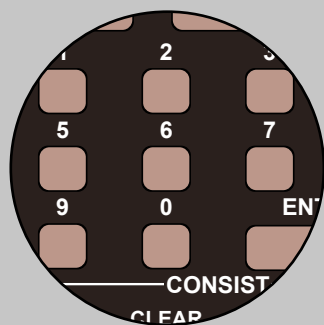

Input  
Command

```
INP:1  L STEP:1  
1=ACCY 2=MACRO >
```

Press

6

```
INP:1  L STEP:1  
1=SET OUTPUT PIN
```

Select the **SET REGISTER** sub menu by pressing **4**, select the register value you wish to change using the **KEYPAD**, then enter the value you wish using the **KEYPAD**, and press **ENTER** to confirm your choice.

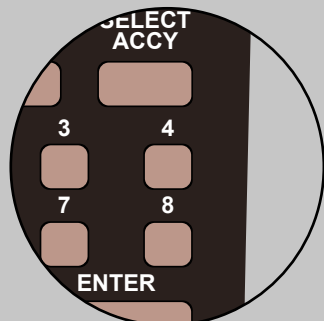

Press

4

```
INP:1  L STEP:1  
REGISTER NUM: 0
```

THEN

Press

1

```
INP:1  L STEP:1  
ENTER VALUE: 1
```

This command adds a numeric value to an internal user-level register. The user registers are numbered 0 to 15 and the numeric values that these registers can hold is limited to 4 bits, i.e. between 0 to 15. You can enter any number between 0 and 15 but remember in 4-bit arithmetic,  $1 + 15$  results in 0. In most circumstances you would use the **ADD** command to increase or decrease a register value.

There is no 'subtract' command but subtraction may be achieved by entering a number between 8 and 15. In 4-bit twos-complement arithmetic, 0 to 7 are considered to be positive numbers and 8 to 15 are negative, i.e. invert the bits, add 1 and mask 4 bits. The Super Panel allows you to enter a number between 1 and 7, and then press the **DIRECTION** key to convert in into a negative number to achieve subtraction.

## 7.6.5 - SKIP IF REGISTER EQUALS VALUE - 5 = Skip If Register Command

From the **INPUT COMMAND** screen press **6** to select the **MORE** screen:

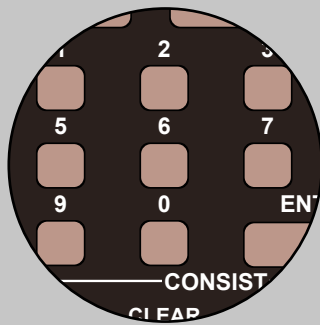

Input  
Command

```
INP:1 L STEP:1  
1=ACCY 2=MACRO >
```

Press

6

```
INP:1 L STEP:1  
1=SET OUTPUT PIN
```

Select the **SKIPIF REG=VAL** sub menu by pressing **5**, select the register number you wish to use, on the **KEYPAD**, then enter the value you wish using the **KEYPAD**, and press **ENTER** to confirm your choice.

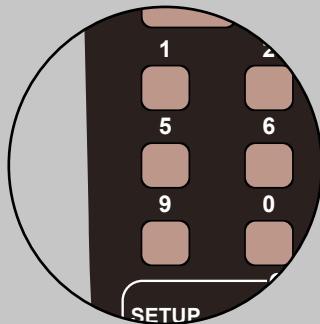

Press

5

THEN

Press

1

```
INP:1 L STEP:1  
REGISTER NUM: 0
```

```
INP:1 L STEP:1  
ENTER VALUE:==1
```

This command allows you to test the value or content of a user-level register and **SKIP** one command if the register **EQUALS** the value or **DOES NOT EQUAL** the value. Registers are number 0 to 15 and are permitted values 0 to 15. Pressing the **DIRECTION** key changes between **EQUALS ==** and **NOT EQUALS !=**. The register values is tested in real time so the value compared is the value 'now'.

## 7.6.6 - WAIT IF REGISTER EQUALS VALUE - 6 = Wait If Register Command

From the **INPUT COMMAND** screen press **6** to select the **MORE** screen:

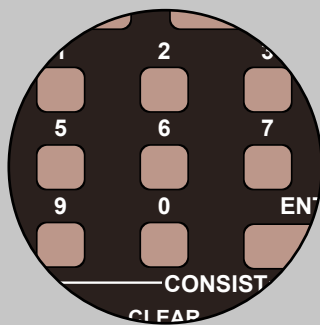

Input  
Command

```
INP:1  L STEP:1  
1=ACCY 2=MACRO >
```

Press

6

```
INP:1  L STEP:1  
1=SET OUTPUT PIN
```

Select the **WAITIF REG=VAL** sub menu by pressing **6**, select the register number you wish to use, on the **KEYPAD**, then enter the value you wish using the **KEYPAD**, and press **ENTER** to confirm your choice.

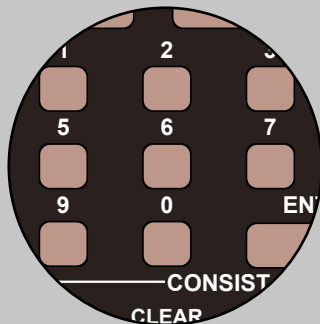

Press

6

THEN

Press

1

```
INP:1  L STEP:1  
REGISTER NUM: 0
```

```
INP:1  L STEP:1  
ENTER VALUE:==1
```

This command allows you to test the value or content of a user-level register and **WAITING** if the register **EQUALS** the value or **DOES NOT EQUAL** the value. Registers are number 0 to 15 and are permitted values 0 to 15.

Pressing the **DIRECTION** key changes between **EQUALS ==** and **NOT EQUALS !=**.

When **EQUALS** is selected, the command **WAITS** if the register equals the value 'now'. When **NOT EQUALS** is selected, the command effectively becomes 'wait until' the register equals the value.

## 7.6.7 - COPY REGISTER FROM REGISTER - 7 = Copy Register Command

From the **INPUT COMMAND** screen press **7** to select the **MORE** screen:

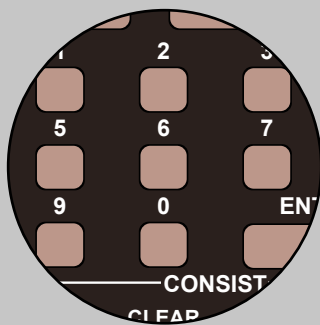

Input  
Command

```
INP:1  L STEP:1  
1=ACCY 2=MACRO >
```

Press

6

```
INP:1  L STEP:1  
7=COPY REGISTER
```

Select the **COPY REGISTER FROM REGISTER** sub menu by pressing **7**, select the register number you wish to copy **TO** first, by entering the value you wish using the **KEYPAD**, and press **ENTER** to confirm your choice.

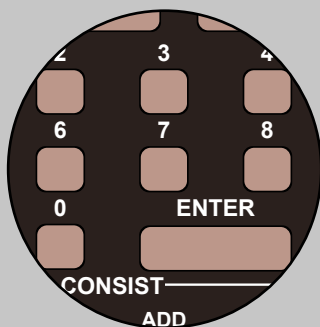

Press

7

THEN

Press

9

```
INP:1  L STEP:1  
REGISTER NUM: 0
```

```
INP:1  L STEP:1  
REGISTER NUM: 9
```

Then enter the register number you wish to copy **FROM** the **KEYPAD**, and press **ENTER** to confirm your choice.

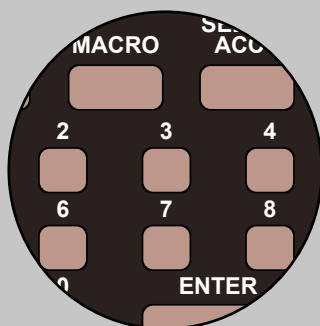

Press

3

THEN

Press

ENTER

```
INP:1  L STEP:1  
COPY FROM REG:3
```

This command allows you to copy one register's contents into another. The Register to receive the copy is entered first, as in the left hand display. Enter the destination register number and press **ENTER**. Its contents will be overwritten.

The Register to copy From is entered second, as in the right hand display. Enter the register number and press **ENTER**. The second, source, register will not be altered.

## 8 - EDIT - 9 = Edit Commands

This range of commands contains the following sub menus:

```
INP:1  L STEP:1  
1=INSERT 2=DELET
```

```
INP:1  L STEP:1  
3=COPY  4=ERASE
```

```
INP:1  L STEP:1  
5=SWAP
```

The Super Panel menu includes a simple editing system, which allows the manipulation of potentially long command sequences. You can insert a blank step in a sequence, delete a step in a sequence, copy all the steps from one input to another, and erase all the steps for an input.

### 8.1 - INSERT - 1 = Insert Command

From the **INPUT COMMAND** screen press **9** to select the **EDIT** screen:

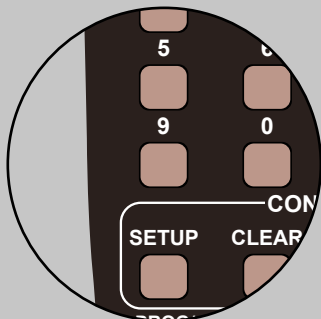

Input  
Command

Press

9

```
INP:1  L STEP:1  
1=ACCY 2=MACRO >
```

```
INP:1  L STEP:1  
1=INSERT 2=DELET
```

From here press **1** to select the **INSERT** screen:

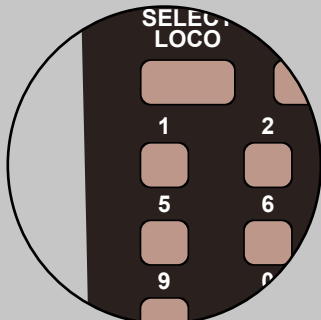

Press

1

THEN

Press

ENTER

```
INP:1  L STEP:1  
ENTER TO INSERT
```

```
INP:1  L STEP:1  
FINISHED
```

This function inserts a blank entry, a **NO-OP** command, at the current step position of the currently selected input, **LOW** or **HIGH** command area. The contents of the current step are moved into the next higher step, the contents of that step are moved up one step, and so on up to step 19. The contents of step 20 are lost. Press **ENTER** to execute the insertion. The screen will automatically revert to the **INPUT COMMAND** screen after 2 seconds.

## 8.2 - DELETE - 2 = Delete Command

From the **INPUT COMMAND** screen press **9** to select the **EDIT** screen:

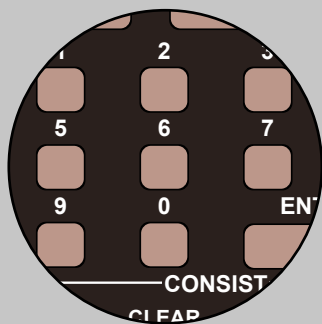

Input  
Command

Press

9

```
INP:1  L STEP:1  
1=ACCY 2=MACRO >
```

```
INP:1  L STEP:1  
1=INSERT 2-DELET
```

From here press **2** to select the **DELETE** screen:

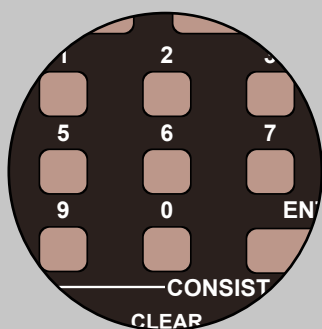

Press

2

THEN

Press

ENTER

```
INP:1  L STEP:1  
ENTER TO DELETE
```

```
INP:1  L STEP:1  
FINISHED
```

This function deletes the contents of the current step of the currently selected input, **LOW** or **HIGH** command area, moves the contents of the next higher step down to this step, and so on until the contents of step 20 are moved down to step 19. A blank entry, a **NO-OP** command, is placed in step 20. Press **ENTER** to execute the insertion. The screen will automatically revert to the **INPUT COMMAND** screen after 2 seconds.

### 8.3 - COPY - 3 = Copy Command

From the **INPUT COMMAND** screen press **9** to select the **EDIT** screen:

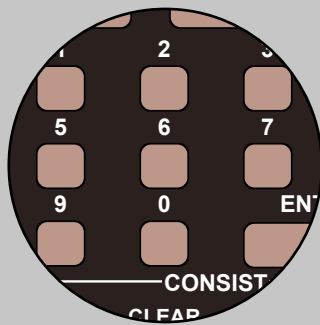

Input  
Command

```
INP:1  L STEP:1  
1=ACCY 2=MACRO >
```

Press

9

```
INP:1  L STEP:1  
1=INSERT 2-DELET
```

From here press **3** to select the **COPY INPUT** screen:

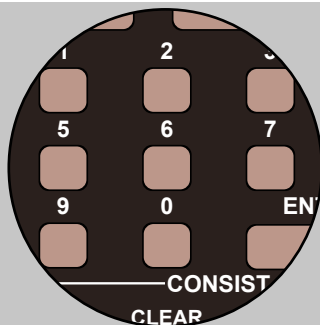

Press

3

THEN

Press

ENTER

```
INP:1  L STEP:1  
DEST INPUT: 0  L
```

```
INP:1  L STEP:1  
FINISHED
```

This function copies the contents of command steps 1 to 20 of the currently selected input to the named input, regardless of the step number that is currently selected. The previous contents of the destination input are lost. This applies to either the **ACTIVE/LOW** or the **INACTIVE/HIGH** command set separately, with the option to copy from the source input's **LOW** set to the destination input's **HIGH** set, and vice versa. You can also copy from the source input's **LOW** or **HIGH** set to the other set of the same input, and vice versa. Press **DIRECTION** to toggle between **LOW** and **HIGH** sets in the destination input. The default is to copy to the same set as the source input, **LOW** or **HIGH**.

```
INP:1  L STEP:1  
DEST INPUT: 14 L
```

```
INP:1  L STEP:1  
DEST INPUT: 15 H
```

Enter the input number to receive the copy and press **ENTER** to execute.

If the command input you are trying to copy does not exist or is the same as that you are trying to copy from, you will see the following screen below, which will then return to the Destination Screen after 2 seconds. Re-enter the correct destination input and try again.

```
INP:1  L STEP:1  
OUT OF RANGE
```

## 8.4 - ERASE - 4 = Erase Command

From the **INPUT COMMAND** screen press **9** to select the **EDIT** screen:

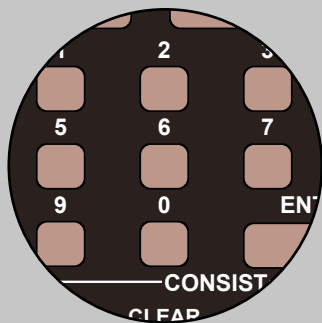

Input  
Command

Press

9

```
INP:1  L STEP:1  
1=ACCY 2=MACRO >
```

```
INP:1  L STEP:1  
1=INSERT 2-DELET
```

From here press **4** to select the **ERASE STEPS** screen:

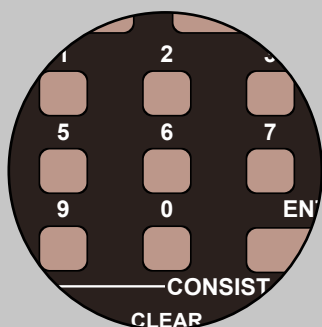

Press

4

THEN

Press

ENTER

```
INP:1  L STEP:1  
ENTER TO ERASE
```

```
INP:1  L STEP:1  
FINISHED
```

This function erases all the steps of the currently selected input, **LOW** or **HIGH** command set. An **END** command is placed in step 1 and **NO-OP** commands are placed in steps 2 to 20. Press **ENTER** to execute the insertion. The screen will automatically revert to the **INPUT COMMAND** screen after 2 seconds.

## 8.5 - SWAP - 5 = Swap Command

From the **INPUT COMMAND** screen press **9** to select the **EDIT** screen:

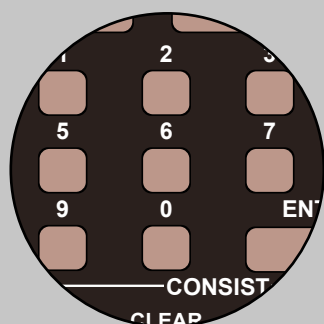

Input  
Command

```
INP:1 L STEP:1  
1=ACCY 2=MACRO >
```

Press

9

```
INP:1 L STEP:1  
1=INSERT 2-DELET
```

From here press **5** to select the **SWAP** screen:

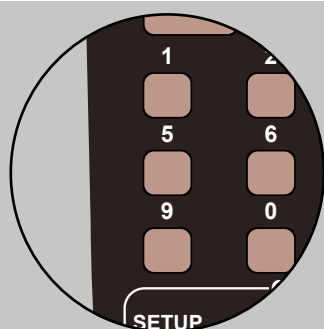

Press

5

THEN

Press

1 then 0

```
INP:1 L STEP:1  
SWAP INPUT: 10 L
```

```
INP:1 L STEP:1  
FINISHED
```

This function swaps the contents of command steps 1 to 20 of the currently selected input with the command steps of the named input, regardless of the step number that is currently selected. The source input commands are copied to the destination input, and the destination input commands are copied to the source input. This applies to either the **active/LOW** or the **inactive/HIGH** command set separately. You can also swap from the source input's **LOW** or **HIGH** set to the other set of the same input, and vice versa. Press **DIRECTION** to toggle between **LOW** and **HIGH** sets in the destination input. The default is to swap to the same set as the source input i.e. **LOW** to **LOW** or **HIGH** to **HIGH**.

If the either the source or destination command sets contain **LINK** command or commands and the link target is the same as the input being written, the target of the link command is changed to the destination input number. **For example**, if input 10 Low step 20 contains a link to Input 10 High and input 10 Low is being swapped with input 15 Low, that link will be edited to Link Input 15 High. The same would apply if there was a link in Input 15 Low to Input 15 High, in that the link would be changed to Link Input 10 High during the swap. This saves you having to edit the Links manually before running the commands in the new locations.

```
INP:1 L STEP:1  
SWAP INPUT: 10 L
```

```
INP:1 L STEP:1  
SWAP INPUT: 10 H
```

## 9 - REVIEW - 2 = Review Commands

From the **MAIN SCREEN** screen press **2** to select the **REVIEW** screen:

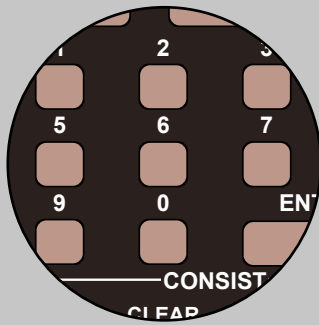

Main  
Screen

Press

2

1=SETUP 2=REVIEW  
3=TEST OPERATION

REVIEW COMMANDS  
INPUT:1 LO/HI:L

Enter the number of the input you want to review, and also choose whether you want the **LOW** or **HIGH** command set by pressing **DIRECTION**. The **DIRECTION** toggles between **LOW** and **HIGH**.

For example look at this screen:

INP:2 L STEP:1  
SGNL:30 ASP:3

This shows *INPUT 2* has a command in *STEP 1* which sets *ASPECT 3* on *SIGNAL 30*.

Pressing **INC** or **ENTER** will step up the next command in the set, pressing **DEC** will step back to the previous command step.

INP:2 L STEP:2  
ACCY/SIGNAL:31

The next screen, above, this command uses *2 STEPS*, so pressing **INC/ENTER** again:

INP:2 L STEP:3  
SGNL:31 ASP:14

This shows *INPUT 2* has a command in *STEP 3* which sets *ASPECT 14* on *SIGNAL 31*.

Pressing **INC** or **ENTER** will step up the next command in the set, pressing **DEC** will step back to the previous command step.

INP:2 L STEP:4  
-END-

The next screen, above, shows the end of the command sequence for the **ACTIVE/LOW** command set.

Pressing **INC/ENTER** again switches automatically to *Step 1* of the **INACTIVE/HIGH** command set:

INP:2 H STEP:1  
SGNL:30 ASP:4

This shows *INPUT 2* has a command in *STEP 1* which sets *ASPECT 4* on *SIGNAL 30*.

Pressing **INC** or **ENTER** will step up the next command in the set, pressing **DEC** will step back to the previous command step.

```
INP:2  H STEP:1
SGNL:30  ASP:4
```

The next screen, above, this command uses *2 STEPS*, so pressing **INC/ENTER** again:

```
INP:2  H STEP:2
SGNL:31  ASP:4
```

This shows *INPUT 2* has a command in *STEP 2* which sets *ASPECT 4* on *SIGNAL 31*.

Pressing **INC** or **ENTER** will step up the next command in the set, pressing **DEC** will step back to the previous command step.

```
INP:2  H STEP:3
- END -
```

Pressing **INC/ENTER** again now switches to *STEP 1* in the *ACTIVE/LOW* command set of *INPUT 3*:

```
INP:3  L STEP:1
ACCY:20  NORM
```

This shows *INPUT 3* has a command in *STEP 1* which sets *ACCESSORY 20* to *NORMAL*.

This process continues for each *INPUT* and *STEP*, both *ACTIVE/LOW* and *INACTIVE/HIGH*.

The review display will automatically switch to the next command set when you have displayed *STEP 20* **OR** when an **END** command is seen. An exception to this is when the review process comes across a **SKIP** or **JUMP** command. In that case, all 20 commands in the command set will be displayed because it is legitimate to have a **SKIP** jumping over an **END** and there may well be more actionable commands following up to *STEP 20*.

While **INC** and **ENTER** will step up from a **LOW** command set to the **HIGH** command set for the same input, and from a **HIGH** command set to the **LOW** command set of the next input, the **DEC** key will only step downwards within the current command set, i.e. it won't switch command sets or inputs.

Pressing the **MACRO** key will switch to the **SETUP INPUT** menu, allowing you to edit the input step currently being reviewed. Pressing **MACRO** again reverts to the input review menu, where you left off. See section 6 – Menu Navigation.

Most commands will be displayed adequately within the two-line display. The exception is function group bits for a locomotive.

## 9.1 - REVIEW - 2 = Reviewing Commands Which Set Function Bits

From the **MAIN SCREEN** screen press **2** to select the **REVIEW** screen:

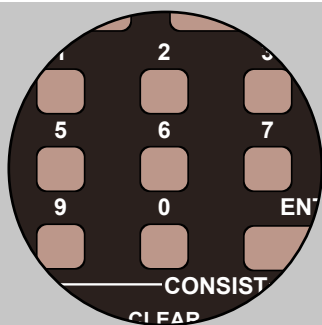

Main  
Screen

Press

2

1=SETUP 2=REVIEW  
3=TEST OPERATION

REVIEW COMMANDS  
INPUT:1 LO/HI:L

Let us review this set of commands that set functions bits. The following shows what such a command looks like upon review. *Step 1* addresses the loco:

INT:16 L STEP 1  
LOCO: 7

Long loco addresses are displayed as 4 or 5 digits with leading zeros. Short loco addresses are displayed as 3 digits with leading spaces, no leading zero.

*Step 2* initially looks like this, indicating that the command will set function group 1, F0 through F4, but it doesn't show the actual function bits.

INT:16 L STEP 2  
LOCO: 7 F04321

Pressing the **EXPN** key will show the actual function bits, see below, which in this case are F0 on and F1 on, F0 is leftmost and F1 is rightmost. Pressing **EXPN** a second time will toggle back to the previous display.

INT:16 L STEP 2  
F04321 1---1

In other function groups, the highest number function bit is on the left and the lowest is on the right, look at the screens below:

INT:16 L STEP 2  
F8-5 -----

INT:16 L STEP 2  
F12-9 -----

INP:16 L STEP:2  
F20-13 -----

INP:16 L STEP:2  
F28-21 -----

## 10 - TESTING - 3 = Testing Commands

From the **MAIN SCREEN** screen press **3** to select the **TEST OPERATION** screen:

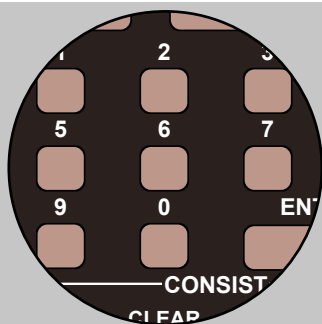

Main  
Screen

Press

3

1=SETUP 2=REVIEW  
3=TEST OPERATION

TEST INPUT MENU  
INPUT:1 LO/HI:L

Enter the number of the input you want to test, and use the **DIRECTION** key to select whether you want the **ACTIVE/LOW** command set or the **INACTIVE/HIGH** command set to execute. Press **ENTER** to make it happen. If the input is configured to act in both **LOW** and **HIGH** states, pressing **DIRECTION** will toggle between **LOW** and **HIGH** and pressing **ENTER** will then activate the opposite command set.

TEST INPUT MENU  
INPUT:1 LO/HI:L

TEST INPUT MENU  
INPUT:1 LO/HI:H

Please note that you do not have to have a switch connected to the input in order to test its actions. The **TEST OPERATION** function allows you to run command streams for inputs that are in the *'unused'* range, including *'outputs'*.

## 11 - DISPLAY INPUT STATUS - 5 = Display Input Status Command

From the **MAIN SCREEN** screen press **5** to select the **INPUT STATUS** screen:

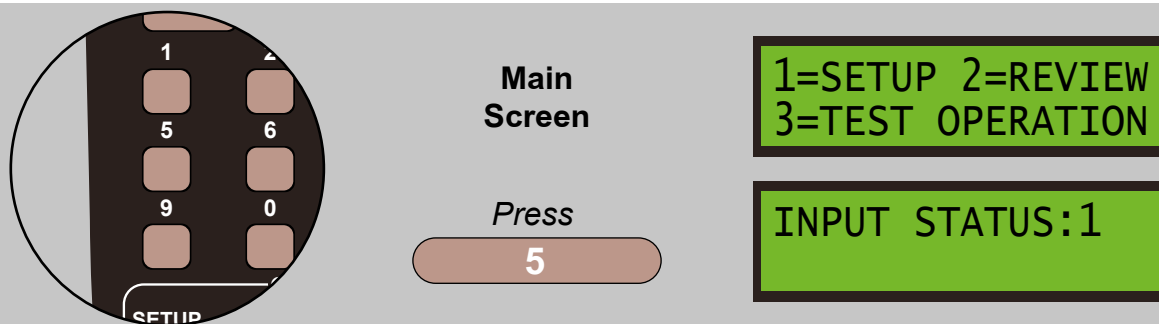

Select the input you want to display and press **ENTER**. Input number 99 is a special case as it allows you to see a list of all the inputs that are busy, executing command streams - see later for an explanation on this. Below is an example of what you may see when 'monitoring' an input:

```
INPUT STATUS:1  
LO BUSY WT DL 01
```

The display will always show **LO** or **HI** in the first two character positions. **LO** means the switch is closed and **HI** means the switch is open. When the input is not busy, this is the physical state of the input. When the input is busy, this is the state that triggered command processing and the **LO** or **HI** will remain until all commands have been processed. Changing the state of the switch while the input is busy will not affect the display or command activity.

The other four fields shown above may then appear, as follows:

**BUSY** - means the input is processing commands and is 'locked' pending the completion of those commands.

**WT** - means the input is **WAITING** for another input to change state. **BUSY** will also be set.

**DL** - means the input is executing a **DELAY**, **BUSY** will also be set.

**01** - is a variable field which shows the step number, and this will generally be that of a **WAIT** or **DELAY**.

If there are no commands executing, the line will only show **LO** or **HI**.

To refresh the display for the same input, press **ENTER** again.

To set the display to refresh automatically every second, press the **MOMENTUM** key. Press **MOMENTUM** again to turn off the repeat.

To display a different input, enter its number and press **ENTER**. You can also press **INC** or **DEC**.

To return to the top-level menu, press **PROG/ESC**.

To **CANCEL** a **WAIT** or **DELAY**, press the **CLEAR** button in the ProCab 'Consist' area. The input's status will then be set to 'not busy' and any commands which may have been pending do not happen.

Please note that an input's command sequence cannot be triggered by changing the state of the attached switch, or via the **INPUT TEST** menu, if the status shows **BUSY**.

If the input being viewed uses a **LINK** to another input, the step number shown will be the step within the linked input's command area while commands in that area are executing. The linked-to input will **NOT** show as busy because it is the initiating input which is executing commands

For example - input 5, step 20 links to input 47, and input 47, step 20 links back to input 5. Input 5 status will show **BUSY** for its own steps 1 to 19, but when step 20 switches to commands in input 47's area, the step number starts again at 01 and runs through to 19 for input 47. When that reaches step 20, command execution switches back to the area for input 5, and so on. Input 47 never shows **BUSY** in this case.

## 11.1 - INPUT 99 STATUS - Display All Inputs That Are Busy Command

From the **MAIN SCREEN** screen press **5** to select the **INPUT STATUS** screen:

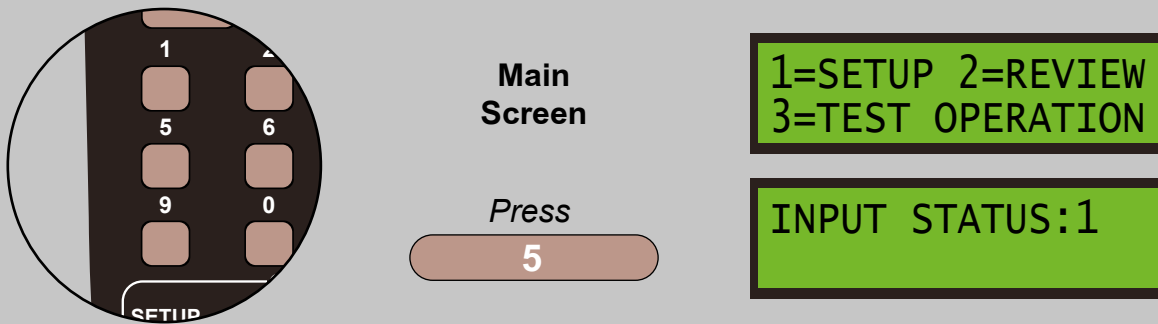

As an example, selecting **INPUT 99** could show the following screen:

```
INPUT STATUS:99  
01 05 11 23 24 >
```

If no inputs are **BUSY**, the screen will show:

```
INPUT STATUS:99  
--
```

In this display, the Super Panel steps through all inputs from 1 to 50, including pseudo inputs, and shows the numbers of any and all inputs that are actively executing commands. This will normally only show up inputs which have a continuous command stream or which are executing **DELAY** or **WAIT** commands.

Up to 5 input numbers can be displayed at a time and if more than 5 inputs are busy, a ">" character will show at the right-hand end of the lower line. Pressing **INC** will start the scan at the highest input that was busy on the last scan, thereby allowing more inputs to be shown. Pressing **DEC** will restart the scan at input 1.

To refresh the display, press **ENTER** again.

To set the display to refresh automatically every second, press the **MOMENTUM** key. Press **MOMENTUM** again to turn off the repeat.

## 12 - TESTING & SETTING OUTPUTS - 6 = Testing & Setting Output Commands

From the **MAIN SCREEN** screen press **6** to select the **TEST OUTPUTS** screen:

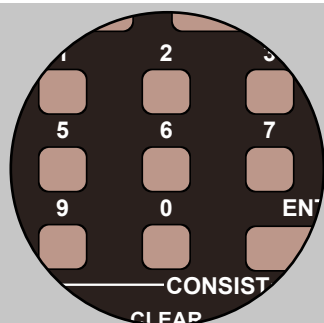

Main  
Screen

Press

6

1=SETUP 2=REVIEW  
3=TEST OPERATION

TEST OUTPUT MENU  
INPUT:1 LO/HI:L

Select the output you want to test, and select whether you want to set the output pin to **LOW** or **HIGH** via the **DIRECTION** key, and press **ENTER**. The output will be driven **LOW** or **HIGH** when you press **ENTER** and any device connected to the output will be activated or deactivated, depending on how it is connected.

Please note that the display refers to **INPUT** on line 2. This is purely because the feature uses code which is common to the **INPUT REVIEW** and **INPUT TEST** menus.

The feature is only available when one or more inputs have been changed into outputs. The message **OUT OF RANGE** will be displayed if an input is selected which is not actually an output, or no outputs are enabled at all.

TEST OUTPUT MENU  
OUT OF RANGE

## 13 - START OF DAY INITIALISATION - 4 = Start Of Day Initialisation Command

From the **MAIN SCREEN** screen press **4** to select the **INPUT INIT MNU** screen:

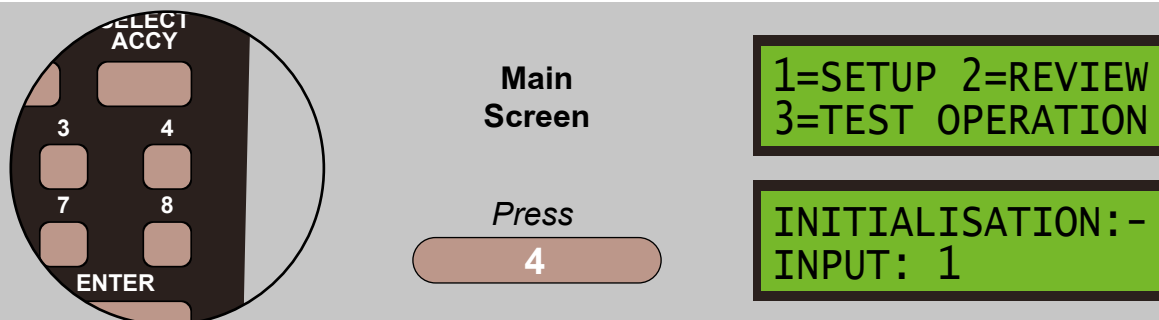

This menu allows you to both review the initialisation table and to adjust it. If you want to check a particular input, enter it here, otherwise enter **1** and press **ENTER**.

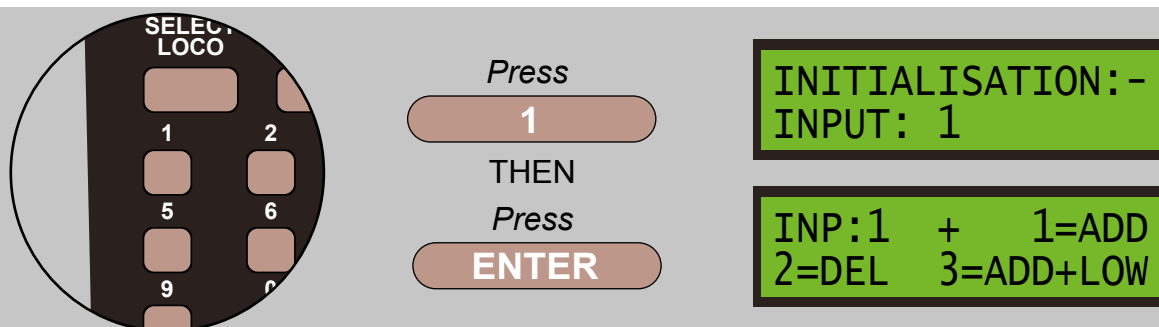

The input number you are looking at is displayed after **INP:**, its current state in the table is indicated by two, or three characters at the position of the **+** in the first line.

There are three main states: **'+'**, **'+L'**, and **'-'**

- +** Means the input **IS IN** the table and initialisation is active.
- +L** Means the input **IS IN** the table with **'force LOW'** set.
- Means the input **IS NOT** in the table, so initialisation is not active.
- #** In the third character position is explained below.

In details these are explained as:

**+** Means that a response will be sent to the command station at *'start-of-day'* which actions the commands that correspond to the state of the switch at that time, i.e. **LOW** or **HIGH**. For turnouts, this will align the turnouts with the current setting of the switches. For pins configured as outputs, this will drive the output **HIGH**. Also see the note **#** display below.

**+L** Means that a response will be sent to the command station at *'start-of-day'* which actions the commands that correspond to the **ACTIVE/LOW** setting of the supposed push-button, even though the button is currently **INACTIVE/HIGH**. This feature can be used to action a particular route setting where ladder routing is in effect. For pins configured as outputs, this will drive the output **LOW**. Also see the note **#** display below.

**-** Means that nothing will happen for this input. For pins configured as outputs, the output will be low by virtue of the fact that **LOW** is the state of an output after a reset.

# There is a special case for initialising an output command stream at start-of-day. It is possible to attach an LED to, say, terminal 47, in output mode, and have commands in that area flash the LED as a heartbeat from 'start-of-day', without the need to have a separate input kick off the activity. If the commands are to be in the **LOW** command area, enter **4** as the initialisation option, and for the **HIGH** command area, enter **5**, **4** will display '+L#' while **5** will display '+ #'. This initialisation mechanism can be used for any output, including pseudo outputs 48 to 50. Please note, inputs are automatically allowed to execute commands at start-of-day, as above.

To simply review the initialisation table, press **INC** to step onto the next higher input, or **DEC** to step back to the previous input. These keys do not make any changes.

If you want to change the setting of an input, press **1, 2, 3, 4** or **5** and the display will be updated. Pressing **ENTER** will enter or re-enter the current or a new state for this input and step on to the next higher input.

There are some situations where you might not want 'start-of-day' initialisation to take place, even though an input may have both **LOW** and **HIGH** commands. An example is a simple motorised turntable, where a centre-off toggle switch moves it anti-clockwise when active to the left and stops it when central, and moves it clockwise when active to the right and stops it when central. To stop the initialisation happening for the two inputs that would be used, select **2=DEC** when you review them, and press **ENTER** to store the new state or states.

An example of the # commands for flashing an LED attached to input 47 as a heartbeat indicator. It is likely where the on-board LED is in 'activity' mode 1. Initialisation option 4 sets the mode for 47 to '+L#', hence activate the low command set. See the table below:

STEP	ACTIVE/LOW COMMAND	STEP	INACTIVE/HIGH COMMAND
1	Drive Output 47 LOW / ON	1	End
2	Delay 1/4 sec 1	2	NO-OP
3	Drive Output 47 HIGH / OFF	3	NO-OP
4	Delay 1/4 sec 6	4	NO-OP
5	Jump to Step 1	5	NO-OP
6	End	6	NO-OP

## 14 - SETTING THE MODE OF AN INPUT - 7 = Setting the Mode Command

From the **MAIN SCREEN** screen press **7** to select the **INPUT MODE MNU** screen:

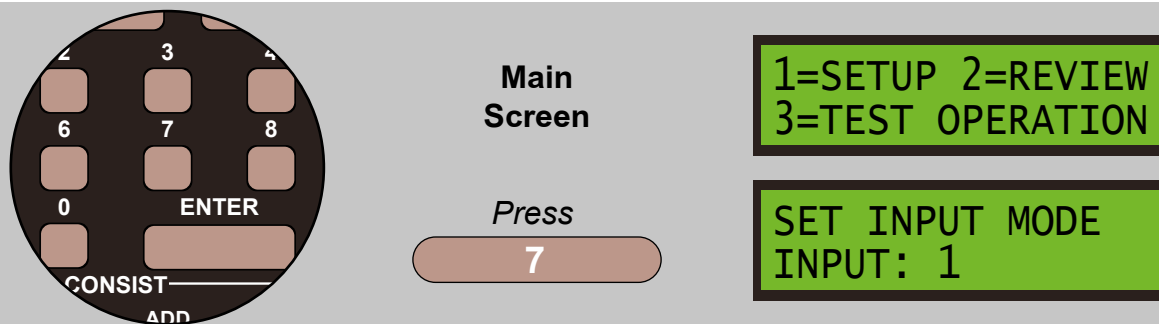

This menu allows you to both review the mode table and to adjust it. Enter the number of the input you want to review or change and press **ENTER**.

```
INPUT: 1  MODE 0
MODE: (0,1,2,3)
```

The current mode of the input is shown at the right-hand end of the top line. To change the mode, enter 0, 1, 2 or 3 and press **ENTER** to store.

To select the next higher or lower input, press **INC** or **DEC** respectively.

The Super Panel has as one of its design aims the ability to activate commands both when an input is taken **LOW**, switch closed, and when it is taken **HIGH**, switch open, but there are some occasions when an input needs to act in one direction only i.e. switch closed. This is achieved by setting a bit in the input's operating mode.

There are also some occasions when the user would like an input to act in the reverse direction to normal, meaning closing a switch actions the switch-open commands, and vice versa. This is achieved by setting a second bit in the input's operating mode.

When these two features are combined, it is possible to have two completely separate command streams entered for an input and the user can select which of the two is actioned when the input is taken low. Logically, this applies mostly to inputs connected to push-buttons where the press action triggers a command stream.

**Mode Bits:** **Bit 0** - when set, the action of opening the switch, releasing a push-button, does nothing.

**Bit 1** - when set, the sense of the switch opening/closing is inverted/reversed.

The mode values available are **0**, **1**, **2** and **3**:

**Mode 0** means both bits are unset, the default and the input actions commands from the **LOW** command set when the switch is closed and from the **HIGH** command set when the switch is opened. With a push-button, the **HIGH** command set is most often empty.

**Mode 1** means that the action of opening the switch, releasing a push-button, does nothing. Thus pressing the button actions commands in the **LOW** command set but releasing it ignores any commands in the **HIGH** command set.

**Mode 2** means that the sense of the input is reversed so that closing a switch, pressing a push-button, actions the **HIGH** command set and opening it, releasing a push-button, actions the **LOW** command set.

**Mode 3** combines modes 1 and 2 so that closing a switch, pressing a push-button, actions the commands in the **HIGH** command set and opening it, releasing the push-button, does nothing. Mode 3 therefore gives the user the option of having two separate command streams in the **LOW** and **HIGH** command areas and switching between the two by switching between modes 1 and 3. This facility has most relevance where the user has programmed train movements behind one or more push-buttons and wants to have the option to operate a different train behind the same push-button.

Bit 1 of the operating mode, the sense reversal, is also referenced when an **ACTIVATE** command activates an input's command stream, so that with bit 1 set, modes 2 or 3, in the target input's mode, an **ACTIVATE LOW** will action the input's **HIGH** command set and vice versa. Thus when an automation set-up uses input commands as subroutines via **ACTIVATE** commands, and the target input has its sense reversed to use an alternate command set, **ACTIVATE** commands issued from other inputs will correctly refer to the alternate command set.

## 15 - SETTING INTERNAL REGISTER VALUES - 8 = Setting & Reviewing Commands

From the MAIN SCREEN screen press **8** to select the INPUT MODE MNU screen:

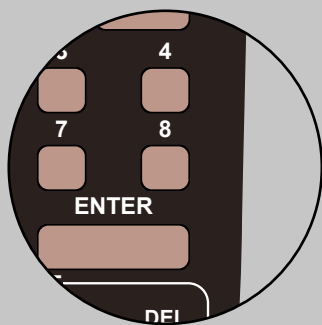

Main  
Screen

Press

8

1=SETUP 2=REVIEW  
3=TEST OPERATION

USER REGISTERS  
REGISTER NUM: 0

This menu allows you to set and review the values held in any of the 16 internal user-level registers. The registers are numbered 0 to 15 and they can hold **ONLY** 4-bit values, 0 to 15.

USER REGISTERS  
ENTER VALUE: 0

All the registers are reset to zero upon Super Panel start-up or reset so the value displayed will start off as 0. A new value between 0 and 15 may be entered and this will be remembered for as long as the Super Panel remains switched on, and not reset.

Please note that a command stream is allowed to alter any register value so this command can be used to view a register as well as set it manually.

## ELECTRICAL SPECIFICATION

External Power Supply: 12 volts DC, 0.75 amp to 1 amp, regulated. Minimum 9v, Maximum 16v.

Remember that when using an external power supply, limits must not be exceeded as this supply directly powers the programming ProCab, whose limits are stated as above.

Power Connector: 2.5mm x 5.5mm barrel plug, centre pin positive. Or via 2-terminal screw connector block.

Power consumption at 12V: 90-120mA nominal.  
0.5mA extra for each input connected to ground.  
104mA extra with all inputs connected to ground.  
120mA extra for a programming ProCab, direct from power supply.

When inputs are configured as outputs driving LEDs:

The software does not put a limit on the number of ports used as outputs, but power considerations limit the number of directly connected LEDs to 4.

Current through the micro controller itself can be reduced to a negligible amount by using external transistors or logic chips as the LED drivers. It is important NOT to connect inductive devices, i.e. relay coils, directly to the Super Panel so use external drivers with suitable back-EMF protection for this. The ULN2003A Darlington relay driver chip is designed for driving external relays and could be used for LEDs as well. The chip has 7 channels.

### **Disclaimer**

The material in this manual is for informational purposes only. The products it describes are subject to change without prior notice, due to the manufacturer's continuous development program.

Layout Concepts makes no representations or warranties with respect to this manual or with respect to the products described herein.

Layout Concepts shall not be liable for any damages, losses, costs or expenses, direct, indirect or incidental, consequential or special, arising out of, or related to the use of this material or the products described herein.

# APPENDIX

## Appendix 1 - Command Considerations Within The Super Panel

Once a loco address is set, all subsequent locomotive commands will be sent to that address. Once an accessory or signal address is set all subsequent output programming commands will be sent to that address. Loco, accessory and signal addresses are stored and processed on a per-input basis so command streams don't get mixed up.

**WAIT** and **DELAY** functions are actioned as background processes and do not block other activity.

**SKIP** functions happen in real time, according to the actual state of the input or inputs/register or registers at the time of execution.

**REGISTERS** 0 to 15 only hold 4-bit values 0 to 15. Addition is as you would expect but subtraction is achieved by adding a '*pseudo-negative*' number 8 to 15, 15 can be considered as -1 so  $1+15=16$  but when this is masked to 4 bits the result is 0.

Commands involving locomotives require two steps in the command memory: one to set the loco address and one more to store the speed or function. Setting a signal aspect where the aspect is greater than 7 also requires two steps.

Setting a CV requires three steps – set the address, loco/accessory/signal, set the CV number, then set the CV data.

Care should be taken when more than one input with multi-step commands, such as the above, may be actioned at the same time. The command station will remember a loco, accessory or signal address or CV number and will apply the next setting that a particular Super Panel supplies for it, but the command station cannot distinguish between commands resulting from different inputs on the same Super Panel.

To explain this further, suppose input 1 selects loco #8 and applies speed forward/10, and input 2 selects loco #16 and applies speed reverse/20. If inputs 1 and 2 were to become active very close together in time, the loco selection from input 2 could override that of input 1 and both speed settings could be applied to loco #16, resulting in no control of loco #8. The Super Panel always sends the appropriate loco/accessory/signal/CV selector before sending the 'setting' information, but it has no control over how the command station actions the requests.

## Appendix 2 - Menu Layout

The diagram shows the layout of the menus in the Super Panel.

### Main Menu

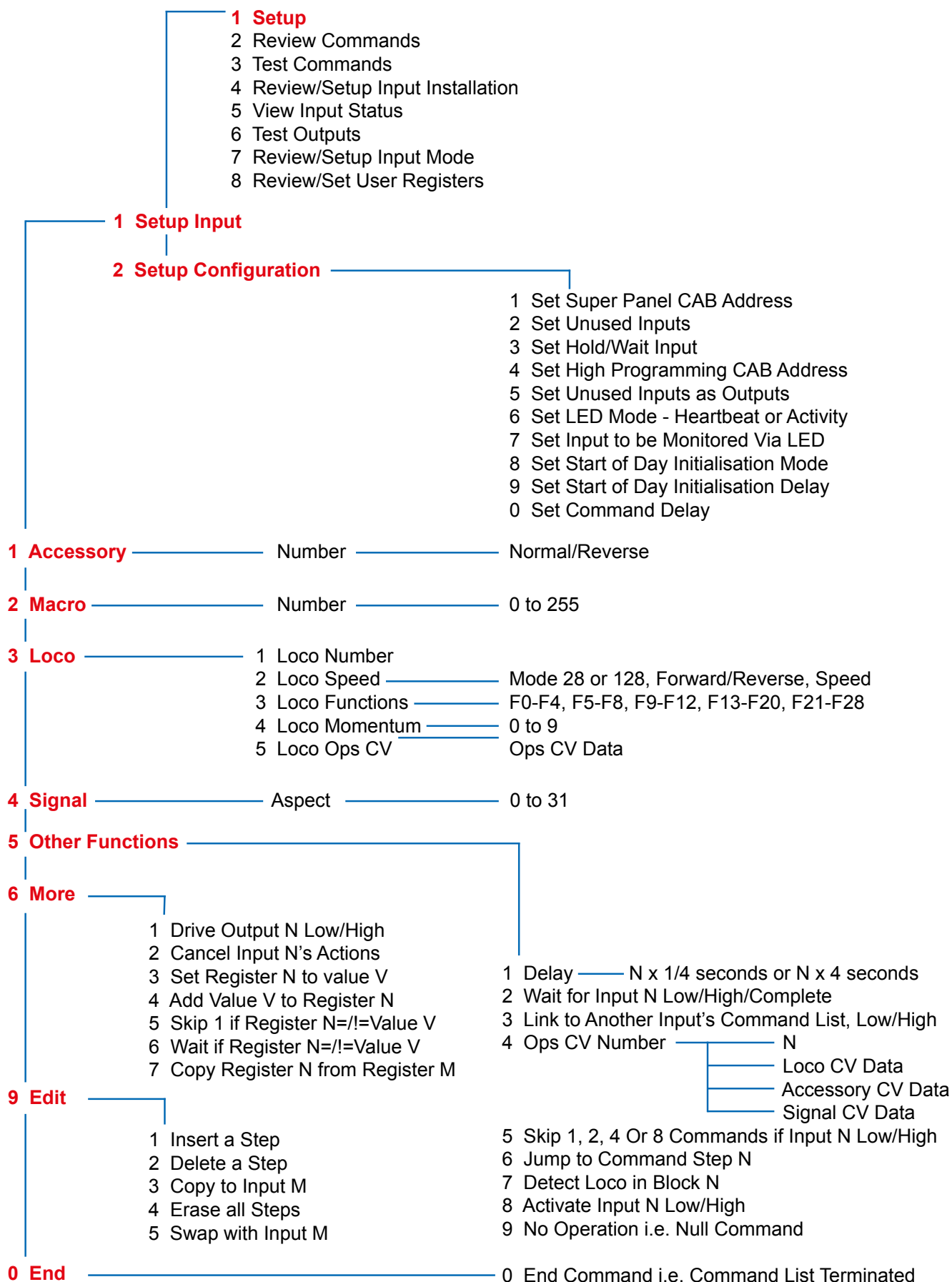

## Appendix 3 - HEX

Bit numbers in a byte - for those not familiar with binary or hexadecimal notation.

Bits in a byte are numbered 0-7, with bit 0 being the least significant bit, on the right, and bit 7 the most significant bit, on the left. Bit 0 has the decimal value 1, while bit 7 has the decimal value 128. Thus bits 0-7 have the decimal values 1, 2, 4, 8, 16, 32, 64 & 128 respectively. If you have more than one bit set in a byte, you add together the decimal values of the bits that are set.

Hexadecimal numbers have a base of 16 instead of 10. Letters A-F represent values 10-15.

For example:

Decimal	Hexadecimal	Binary
0	0	0000
1	1	0001
2	2	0010
3	3	0011
4	4	0100
5	5	0101
6	6	0110
7	7	0111
8	8	1000
9	9	1001
10	A	1010
11	B	1011
12	C	1100
13	D	1101
14	E	1110
15	F	1111
16	10	1 0000
32	20	10 0000
64	40	100 0000
128	80	1000 0000
255	FF	1111 1111

## Appendix 4 - Programming Sheets

The Super Panel is delivered with all inputs having an **END** command in step 1 of the **LOW** and **HIGH** command areas. All steps are filled with **NO-OP** commands

STEP	ACTIVE /LOW COMMANDS
1	
2	
3	
4	
5	
6	
7	
8	
9	
11	
12	
13	
14	
15	
16	
17	
18	
19	
20	

STEP	INACTIVE /HIGH COMMANDS
1	
2	
3	
4	
5	
6	
7	
8	
9	
11	
12	
13	
14	
15	
16	
17	
18	
19	
20	

STEP	ACTIVE / LOW COMMANDS
1	
2	
3	
4	

STEP	ACTIVE / LOW COMMANDS
1	
2	
3	
4	

STEP	ACTIVE / LOW COMMANDS
1	
2	
3	
4	

STEP	ACTIVE / LOW COMMANDS
1	
2	
3	
4	

STEP	INACTIVE / HIGH COMMANDS
1	
2	
3	
4	

STEP	INACTIVE / HIGH COMMANDS
1	
2	
3	
4	

STEP	INACTIVE / HIGH COMMANDS
1	
2	
3	
4	

STEP	INACTIVE / HIGH COMMANDS
1	
2	
3	
4	

**LAYOUT**

**##### CONCEPTS #####**

**Unit E  
The Sidings  
Settle  
North Yorkshire  
United Kingdom  
BD24 9RP**

**Phone: +44 (0) 1729 821 080**

**[www.layoutconcepts.com](http://www.layoutconcepts.com)**

**[salesuk@layoutconcepts.com](mailto:salesuk@layoutconcepts.com)**